

TRADITION + INNOVATION = FUTURE

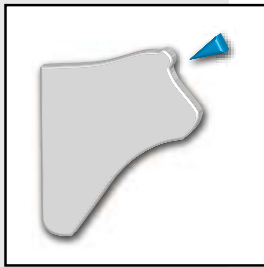

STUNNING

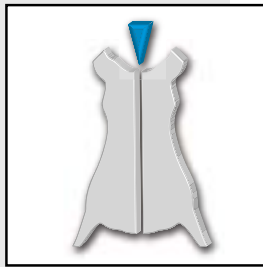

SLAUGHTERING

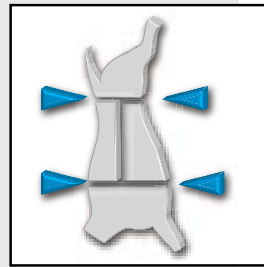

PRIMAL CUTTING

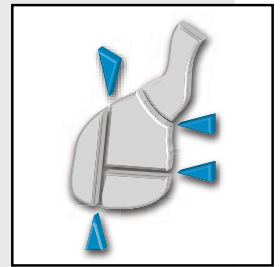

TRIMMING

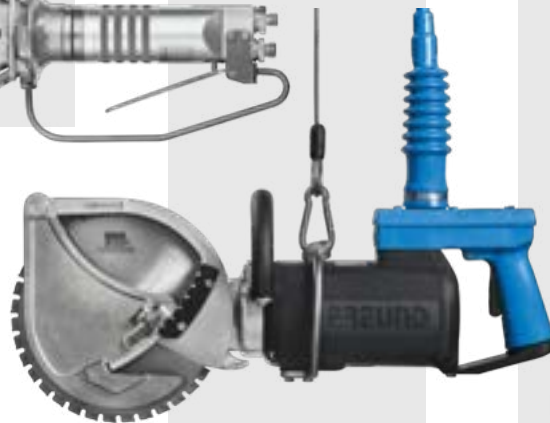
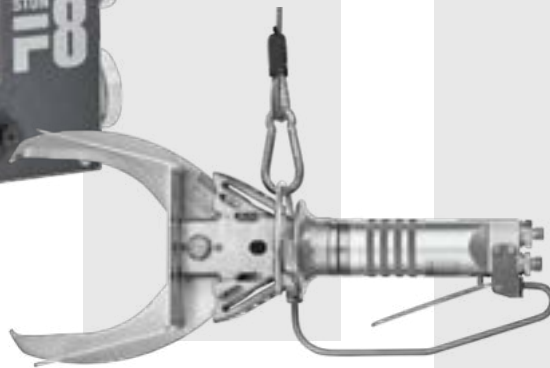

PRODUCT CATALOGUE
2024





A FAMILY-OWNED COMPANY THAT REFLECTS THE TIMES



© Stadtarchiv Solingen

SOLINGEN 18th century

Engagement with blade and cutlery manufacturing in Solingen (Barl & Wald)

19th century WUPPERTAL

First mention of a forge in Wuppertal.



As a result of the hunger crisis following World War I, the family flees to the countryside in the Paderborn area. Products and services relating to cutlery for butchers are offered there.



PADERBORN 1920

1928 PADERBORN

Walter Freund registers his fitter's shop for the production of blades, grinding machines and butcher's tools in Paderborn.



Blade sharpening machines are developed and produced along side sausage lifters and other articles.



1955 PADERBORN

Construction of the first circular rib saws Record R5 and Record Junior.

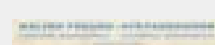

Walter Freund exhibits his own products for the first time at the IFFA trade fair.

COLOGNE 1959

1962 PADERBORN

The success model, Record62, starts up, a rib saw with an electric drive.



Reinhard Freund builds a modern factory building in Schulze-Delitzsch-Straße in Paderborn.



1970 PADERBORN

The Record62 is replaced by the circular breaking saw K18-01 featuring a motor of protection class IP24 which was developed in-house. The strategy is increasingly aligned to tools for cutting and slaughtering.



PADERBORN 1977

The first jigsaw ST40-11 is produced.



1979 PADERBORN

Technology launch - the first CNC lathe enters service.



PADERBORN 1980

The first expansion of the production hall is carried out.

1984 PADERBORN

Market launch of the splitter band saw.



PADERBORN 1990

Expansion of the product range to include hydraulic shears.



TRADITION + INNOVATION = FUTURE

As a globally operating manufacturer of tools for cutting and slaughtering, we have made it our goal to support the meat extraction process in a way that is conducive to the well-being of the animal, socially responsible and beneficial to our customers.

Ethical animal welfare requirements coupled with a highly cost-effective procedure and optimum meat quality is what needs to be achieved.

That is why we develop and produce extremely effective and stable machines for the entire process chain. From stunning and slaughtering to cutting up and refining, we ensure that our machines make your production process more efficient in a sustainable manner.

The development and improvement of our services always incorporates regular dialogue with our customers and partners in over 100 countries as well as centuries-old experience as a family-run and family-owned company.

Our FREUND in-house service department will be happy to provide you with comprehensive and expert advice and show you how you can use our services to generate the greatest benefit for your business.

Quality from a single source – For trade and industry

Made in Germany.

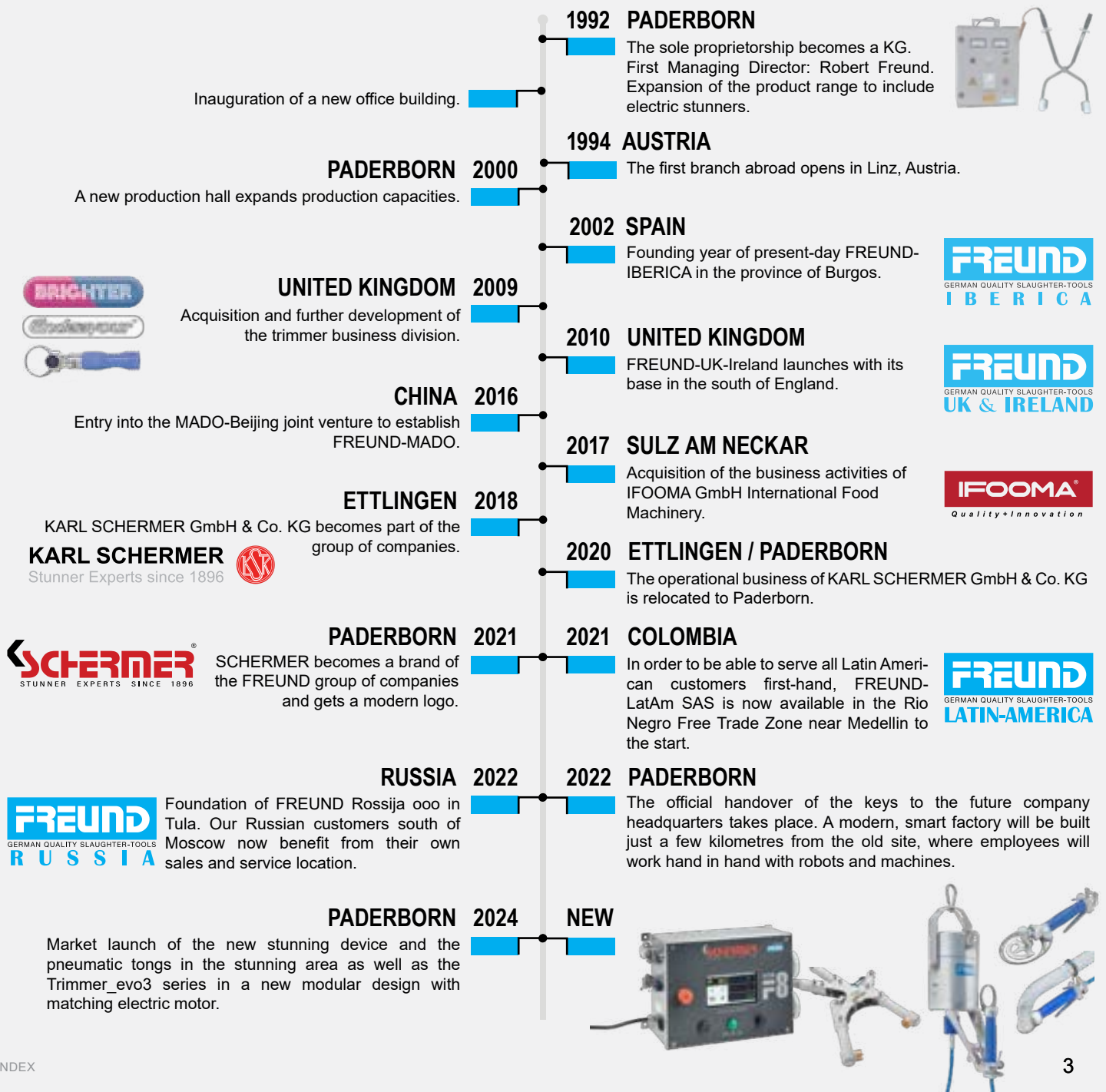



STUNNING

STUNNING





Professional stunning plays a very important role in the slaughtering process.

Ethical animal welfare requirements coupled with a sustainable, cost-effective procedure and optimum meat quality is what needs to be achieved. In this regard, FREUND offers the perfect solution with an extensive product range for electrical stunning with high-frequency constant current with high-frequency constant current or constant voltage.

Programmable stunners with a recording function for transparent documentation of the on-going process and suitable stun tongs for every animal size make an efficient slaughtering yield possible.

The FREUND service department supports the user by offering expert advice in all matters relating to the products.

CONTENTS

	Droving	6-7
	Stunning	8-27
	▶ Stun tongs	8-11
	▶ Electric stunning devices and accessories	12-21
	▶ Captive bolt stunner	22
	▶ Compressed air compressors	22-23
	▶ SCHERMER Captive bolt stunners / accessories	24-27
	▶ Cartridges	27

MOVIT-M

Animal drover / Droving aid



Swatter for effective droving in a manner conducive to the well-being of the animal

- Pain-free droving: no electric shocks, no sharp tips
- No sudden noise and contact trigger
- Reduced risk of bleeding and dead animals
- The MOVIT-M animal drover complies with the applicable animal welfare requirements

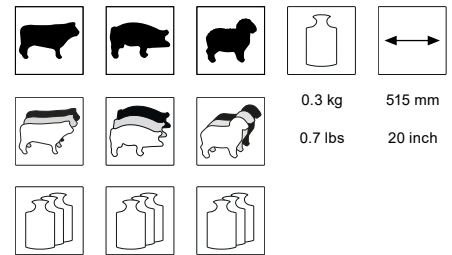

KAWE 8001

Animal drover (electronical)



Electronic animal drover for effective droving of the animal

- Electronic control, therefore no mechanical wear
- Battery-operated (2 Monocells 1,5V)*
- Maintenance-free electronics
- Housing made of robust plastic

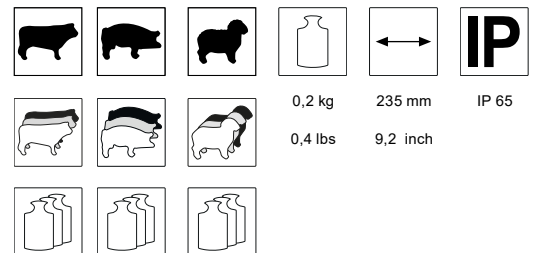

*Not included in the scope of delivery due to transport regulations



▶ Not permissible for use in plants within a member state of the European Union (TierSchIV 1099 vom 01.03.2013)

KAWE 21

Animal drover (electronical)

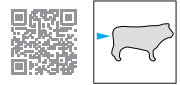

Electronic animal drover for effective droving in a manner conducive to the well-being of the animal

- Automatic switch-off of the current pulse after 1 second
- Electronic control, therefore no mechanical wear
- Battery-operated (2 Monocells 1,5V)*
- Visual display
- Maintenance-free electronics
- Housing made of robust plastic
- The KAWE 21 complies with the applicable animal welfare requirements

			0,4 kg	270 mm	IP 65
			0,9 lbs	10,6 inch	

*Not included in the scope of delivery due to transport regulations

EXTENSION ROD / VERLÄNGERUNGSSTAB

Extension rod for KAWE 21 / KAWE 8001

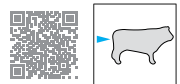

- increases the user's reach
- effortless insertion
- compatible with KAWE 8001 and KAWE 21
- made of robust plastic

			0.2 kg	760 mm	
			0.4 lbs	30 inch	

STUN-TONG-EP STEEL

Electric stun tong



Electric stun tong for for suckling pig and pig head stunning

- spike electrodes provide better skin contact and prevent slipping
- Electrode quick-change system
- Stable stainless steel design ** INOX / rust-free **
- Robust pivot joint
- Non-slip handle
- Wear-resistant spiral cable SK



3.2 kg
7 lbs



STUN-TONG-EA STEEL

Electric stun tong



Electric stun tong for sheep, lambs & goats

- With hexagon electrodes
- Extra long spike for optimum skin contact
- Electrode quick-change system
- Stable stainless steel design ** INOX / rust-free **
- Robust pivot joint
- Non-slip handle
- Wear-resistant spiral cable SK



3.2 kg
7 lbs



STUN-TONG-ES STEEL

Electric stun tong



Electric stun tong for pigs and sows

- With hexagonal electrodes
- Electrode quick-change system
- Wide opening range for head and heart stunning
- Angled, ergonomic handle
- Stable stainless steel design ** INOX / rust-free **
- Wear-resistant spiral cable



3.5 kg
7.7 lbs



STUN-TONG-EPP2

Electric stun tong (pneumatic)



Electric stun tong, pneumatic

- Can be integrated for stunning animals in stun traps or stunning animals in restrainers
- Electrode quick-change system
- Significant relief for the user thanks to the pneumatic drive for opening and closing

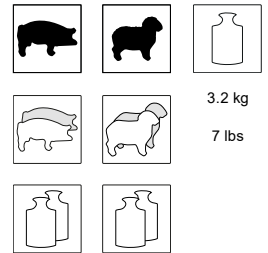

STUN-TONG-EPP3

Electric stun tong (pneumatic)

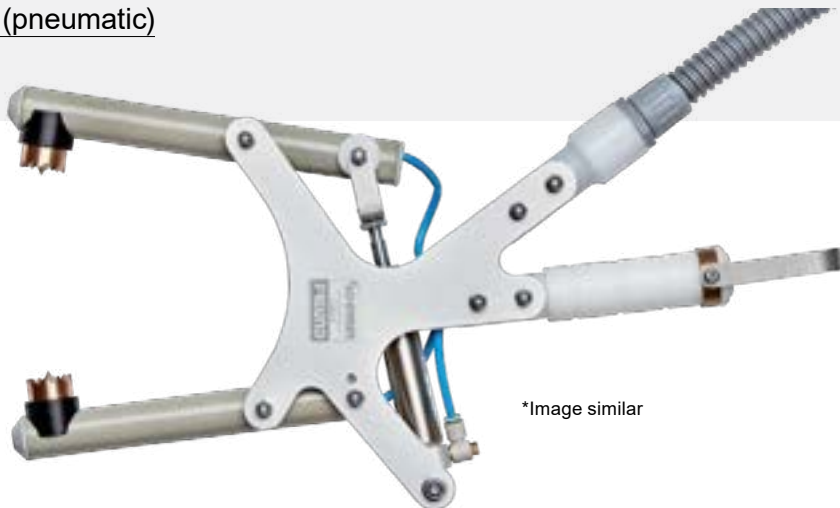
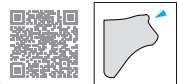

*Image similar

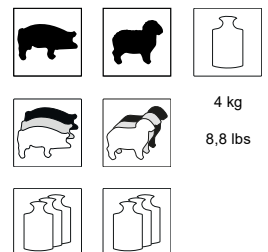

For trap stunning or for stunning in the restrainer for pigs and sheep

- Easy and safe to use
- Adjustable in 2 opening sizes:
 - ▶ for pig/sheep
 - ▶ for sow
- Significant relief for the user thanks to pneumatic closing process and spring tensioner (optionally available)
- Innovative material alloy of the electrode for optimal current flow and significantly increased durability
- Prepared for use with an F-series stunning device in conjunction with an interface control box
- Can be used in combination with a manual or automatic cardiac electrode

OPTIONAL:

- ▶ Electrodes with long thorn for sheep and sows

ZK-1

Electric stun tong

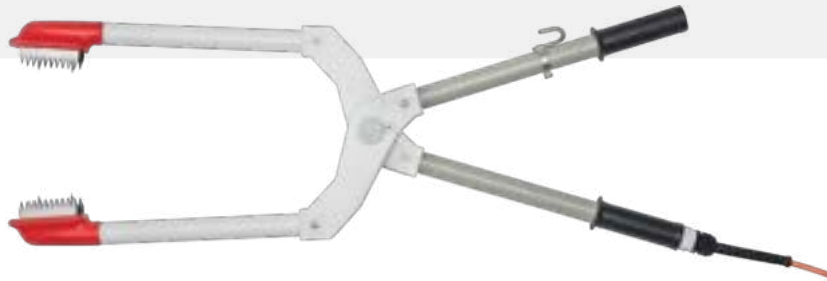

- Plastic side pieces
- Larger opening angle due to extended side pieces for combined heart-brain stunning in bays
- Spiral cable
- CEE plug

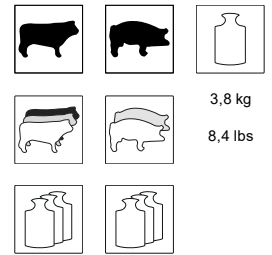

ZK-2

Electric stun tong (standard)



- Plastic side pieces
- Large opening angle for combined heart-brain stunning in bays
- Spiral cable

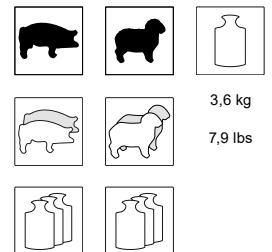

ZK-3

Electric stun tong

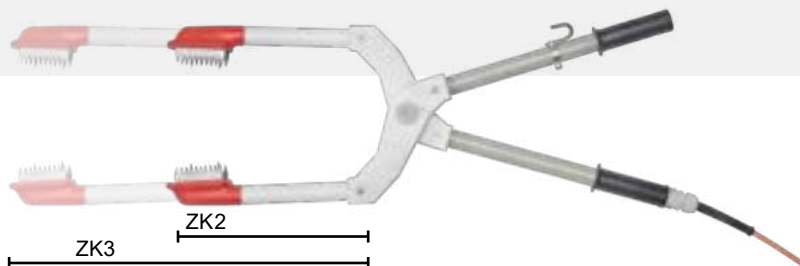

- Plastic side pieces
- Large opening angle for combined heart-brain stunning in bays
- Spiral cable



ZK-4

Electric stun tong

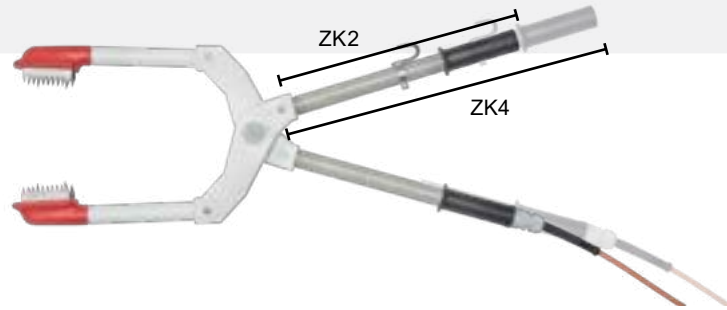
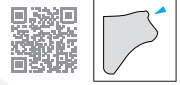

- Plastic side pieces
- Large opening angle for combined heart-brain stunning in bays
- Spiral cable

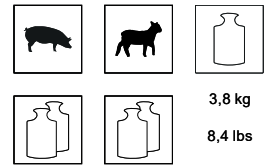

Z-KT

Electric stun tong



- Plastic side pieces
- Spiral cable

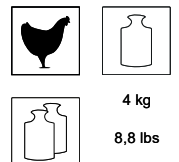

STUN-F8

Stunning device, suitable for industrial use and high frequency
(constant current or voltage)



NEW!

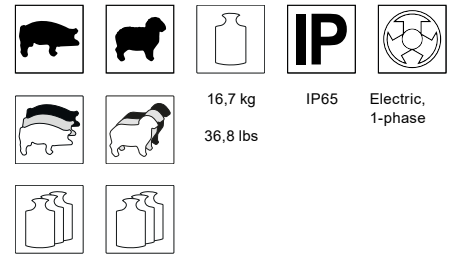

*The images show examples of the screen displays

- High-frequency constant current or constant voltage electric stunning device for trap or restrainer stunning in industrial and medium-sized companies
- USB/LAN/WLAN interface for data/parameter transfer
- Stunning programs pre-installed and can be expanded to up to 25 stunning programs if required
- Predefined stunning parameters for optimal stunning effect and best possible meat quality, individually adjustable on request
- Remote parameterization of the device is possible upon customer request
- High-resolution touchscreen for setting and displaying key parameters during stunning
- Signal provision for external controls (e.g. pneumatic peripherals, PLC, signaling devices)
- Rapid current increase up to 3.5 A
- Internal storage space for approx. 1.2 million stunning sessions
- Integrated piece counter (updated daily)
- Reliable, industrial-grade electronic transformer
- Easy installation and operation for the user
- Robust stainless steel housing with wall bracket complies with the valid legal and normative requirements:
 - the current COUNCIL REGULATION (EC) No. 1099/2009 of September 24, 2009 on the protection of animals at the time of killing
 - the Regulation on the protection of animals in connection with slaughter or killing and on the implementation of Council Regulation (EC) No. 1099/2009 (Animal Welfare-Slaughter Ordinance - TierSchIV)
 - the EU Low Voltage Directive
 - the relevant VDE regulations

SCHERMER STUN PORTAL

Web server for data recording and remote parameterization (for the STUN-F series)



NEW!

www.schermer-stun-portal.com



SCHERMER STUN-Portal English log off

device list: stuns

statistics: when record updated

stuns Freund F8

total count	no. of stuns per day	start in time	program	head current	head time	heart current	heart time
851	1	25.01.2024, 12:22:21	25	1,35 A	6,00 s	0,80 A	2,00 s
852	2	25.01.2024, 12:22:26	25	1,35 A	6,00 s	0,80 A	2,00 s
853	3	25.01.2024, 12:22:36	25	1,35 A	6,00 s	0,80 A	2,00 s
854	4	25.01.2024, 12:22:43	25	1,35 A	6,00 s	0,80 A	2,00 s
855	5	25.01.2024, 12:22:52	25	1,35 A	6,00 s	0,80 A	2,00 s
856	6	25.01.2024, 12:22:59	25	1,35 A	6,00 s	0,80 A	2,00 s
857	7	25.01.2024, 12:23:06	25	1,35 A	6,00 s	0,80 A	2,00 s
858	8	25.01.2024, 12:23:11	25	1,35 A	6,00 s	0,80 A	2,00 s
859	9	25.01.2024, 12:23:20	25	1,35 A	6,00 s	0,80 A	2,00 s
860	10	25.01.2024, 12:23:27	25	1,35 A	6,00 s	0,80 A	2,00 s
861	11	25.01.2024, 12:23:34	25	1,35 A	6,00 s	0,80 A	2,00 s
862	12	25.01.2024, 12:23:40	25	1,35 A	6,00 s	0,80 A	2,00 s
863	13	25.01.2024, 12:23:47	25	1,35 A	6,00 s	0,80 A	2,00 s

show full table only

PDF print daily tab

PDF report complete

PDF report (single)

Printable PDF view of the daily table

daily tab:

stuns:	13
stuns ok:	12
stuns error:	1
error rate in %:	7,6%

▲ The figure shows an example of the daily statistics of the anesthesia carried out.

▶ The figure shows an excerpt from the report on the anesthesia carried out.

SCHERMER A BRAND OF **FREUND**
STUNNER EXPERTS SINCE 1896

device: Freund F8 page: 2 / 2

time:

total count	no. of stuns	start in time	program	device	head current	head time	heart current	heart time
851	1	25.01.2024 12:22:21	25		1,35 A	6,00 s	0,80 A	2,00 s
852	2	25.01.2024 12:22:26	25		1,35 A	6,00 s	0,80 A	2,00 s
853	3	25.01.2024 12:22:36	25		1,35 A	6,00 s	0,80 A	2,00 s
854	4	25.01.2024 12:22:43	25		1,35 A	6,00 s	0,80 A	2,00 s
855	5	25.01.2024 12:22:52	25		1,35 A	6,00 s	0,80 A	2,00 s
856	6	25.01.2024 12:22:59	25		1,35 A	6,00 s	0,80 A	2,00 s
857	7	25.01.2024 12:23:06	25		1,35 A	6,00 s	0,80 A	2,00 s
858	8	25.01.2024 12:23:11	25		1,35 A	6,00 s	0,80 A	2,00 s
859	9	25.01.2024 12:23:20	25		1,35 A	6,00 s	0,80 A	2,00 s
860	10	25.01.2024 12:23:27	25		1,35 A	6,00 s	0,80 A	2,00 s
861	11	25.01.2024 12:23:34	25		1,35 A	6,00 s	0,80 A	2,00 s
862	12	25.01.2024 12:23:40	25		1,35 A	6,00 s	0,80 A	2,00 s
863	13	25.01.2024 12:23:47	25		1,35 A	6,00 s	0,80 A	2,00 s

- If there is an existing network connection, the stunning data and the stunning parameters set on the device are automatically saved
- In offline operation, alternative data transfer via USB stick is possible
- Upon customer request, remote parameterization of the stunning device is possible via the SCHERMER Stun portal
- Recording, displaying and evaluating the stunning processes with all relevant data
- Evaluation of anesthesia data to create daily, weekly and monthly statistics directly in the portal. All statistics can be printed and/or saved (PDF)
- Extensive filter function (e.g. error rates) for analyzing the stunning data
- Additional device access with different authorizations is possible

STUN-TONG-EPP3 F-Serie

Electric stun tong (pneumatic)



NEW!

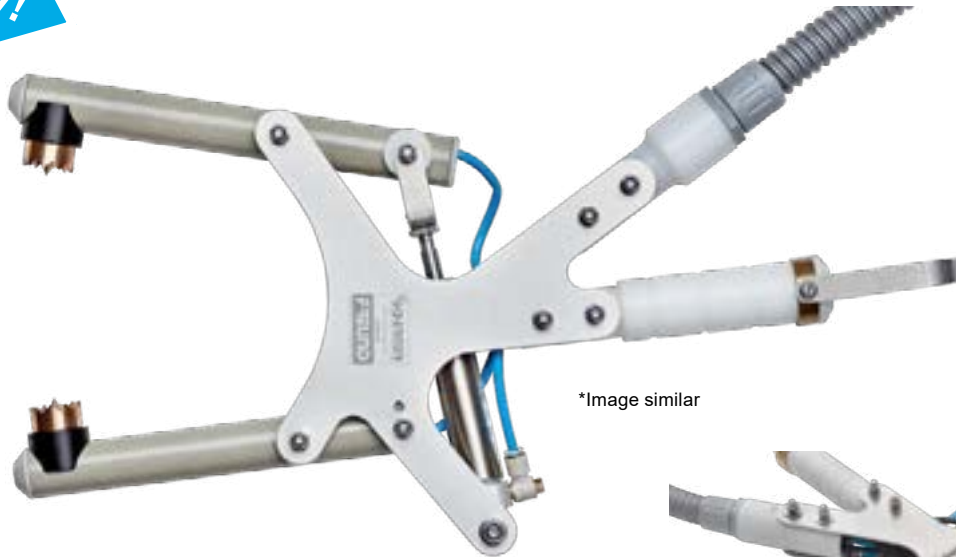

*Image similar

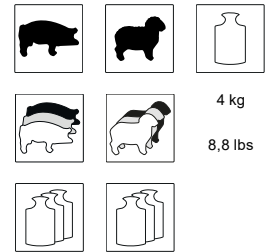

For trap stunning or for stunning in the restrainer for pigs and sheep

- Easy and safe to use
- Adjustable in 2 opening sizes:
 - ▶ for pig/sheep
 - ▶ for sow
- Significant relief for the user thanks to pneumatic closing process and spring tensioner (optionally available)
- Innovative material alloy of the electrode for optimal current flow and significantly increased durability
- Prepared for use with an F-series stunning device in conjunction with an interface control box
- Can be used in combination with a manual or automatic cardiac electrode

OPTIONAL:

- ▶ Electrodes with long thorn for sheep and sows



STUN-IF1-F8 / STUN-IF2-F8

Interface control boxes (suitable for STUN-F8)



NEW!



2,1 kg
4,6 lbs



IP44

6,2 kg
13,7 lbs

IP44

Additional devices for the STUN-F8 stunning device for controlling pneumatic components.

Available in two versions:

- **STUN-IF1-F8** offers the possibility of controlling a pneumatic stun tong (e.g. STUN-TONG-EPP3 F-series)
- **STUN-IF2-F8** offers the possibility of controlling a pneumatic stun tong (e.g. STUN-TONG-EPP3 F-series), as well as up to 2 pneumatic cylinders on a heart electrode (e.g. STUN-HE-PP)

STUN-HE-PP

Heart electrode, automatically movable



NEW!

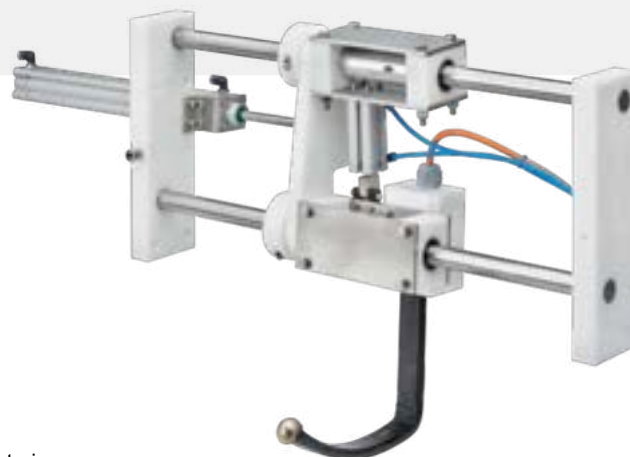

17,4 kg



IP44

38,4 lbs

- Designed for integration into stun traps and restrainers
- Enables automated heart circulation in the industrial slaughter process
- The constant, consistent process flow supports good stunning and immobilization as well as high meat quality, which depends on the stunning process
- Left/right installation position available
- Installation in existing system possible (if compatible)

STUN-E8XXL

Stunning device (constant current & high frequency)

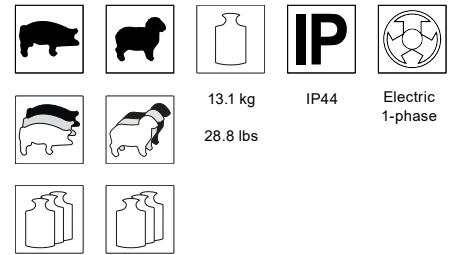

Electronic, high-frequency, constant-current, cloud-enabled, stunning device for Industry. Also suitable for stunning animals in stun traps

- 8 pre-installed stunning programs, individually adaptable
- Can be extended to up to 24 stunning programs
- LCD display with 40 characters for real time display of program number, current, voltage, frequency and stunning time
- Linear frequency ramp, without abrupt gradations
- Acoustic and visual display for errors and the end of stunning
- 6 convenient buttons for program selection and programming
- Control of a heart electrode possible
- Network-compatible (Ethernet RJ45)
- Second outlet for separate heart-electrode
- Remote programming of the parameter data sets possible via a web interface
- Access to stun data via the web interface with daily/weekly/monthly statistics
- Internal data storage for additional backup
- Remote control outlet for pneumatic stun tong and pneumatic heart electrode
- Stun data coupling of two stunners via master/slave control (all data of one stunning procedure in one diagram)

STUN-TONG-EPP3 E-Serie

Electric stun tong (pneumatic)



NEW!

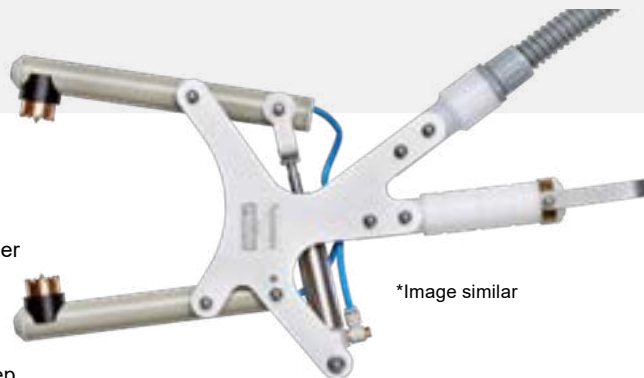
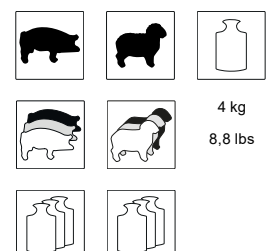

*Image similar



For trap stunning or for stunning in the restrainer for pigs and sheep

- Easy and safe to use
- Adjustable in 2 opening sizes:
 - for pig/sheep
 - for sow
- Significant relief for the user thanks to pneumatic closing process and spring tensioner (optionally available)
- Innovative material alloy of the electrode for optimal current flow and significantly increased durability
- Prepared for use with an F-series stunning device in conjunction with an interface control box
- Can be used in combination with a manual or automatic cardiac electrode



OPTIONAL:

- Electrodes with long thorn for sheep and sows

STUNDATA SERVER

Web server for data recording (for STUN-E series)



<https://stun.freund-germany.com/user/login>

- Automatic storage of stunning data is only possible with a network connection
- User-friendly setting options for the stunning parameters via the portal (current, frequency + the times for the stunning process and the stunning duration) for an optimal stunning result
- Recording and evaluation of stunning processes in the portal with date, time, stunning current, filterable by current date
- Optimal adaptation of the anesthesia through the ability to set various parameters (current, frequency + stun times and duration)
- Parameter settings can be saved and transferred via the Internet

STUN-IF1-E8 / STUN-IF2-E8

Interface control boxes (suitable for STUN-E8XXL)



3,2 kg	IP44
7,1 lbs	
7,5 kg	IP44
16,5 lbs	

Additional devices for the STUN-F8 stunning device for controlling pneumatic components.

Available in two versions:

- **STUN-IF1-E8** offers the possibility of controlling a pneumatic stun tong (e.g. STUN-TONG-EPP3 F-series)
- **STUN-IF2-E8** offers the possibility of controlling a pneumatic stun tong (e.g. STUN-TONG-EPP3 F-series), as well as up to 2 pneumatic cylinders on a heart electrode (e.g. STUN-HE-PP)

STUN-HE-PP

Heart electrode, automatically movable

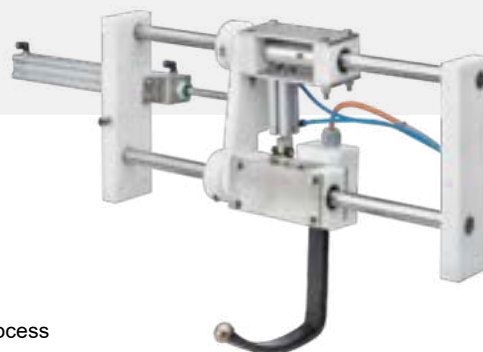

17,4 kg	IP44
38,4 lbs	

- Designed for integration into stun traps and restrainers
- Enables automated heart circulation in the industrial slaughter process
- The constant, consistent process flow supports good stunning and immobilization as well as high meat quality, which depends on the stunning process
- Left/right installation position available
- Installation in existing system possible (if compatible)

STUN-E6XXL

Stunning device (constant current & high frequency)



Electronic, high-frequency, constant-current, cloudenabled stunning device for the middle application

- 8 pre-installed stunning programs, individually adaptable
- Can be extended to up to 24 stunning programs
- LCD display with 40 characters for real time display of program number, current, voltage, frequency and stunning time
- Linear frequency ramp, without abrupt gradations
- Acoustic and visual display for errors and the end of stunning
- 6 convenient buttons for program selection and programming
- Network-compatible (Ethernet RJ45)
- Remote programming of the parameter data sets possible via a web interface
- Access to stun data via the web interface with daily/weekly/monthly statistics
- Internal data storage for additional backup

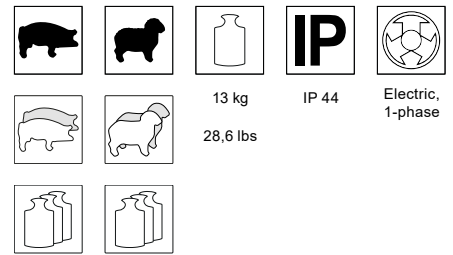

STUN DATA ONLINE

Stun No.	Date/Time	Current	Head/Neck	Time	Head/Neck	Time	Head/Neck	Time	Head/Neck
0.336	2017-05-18 11:25:23	0.15A	0.9 sec						
0.335	2017-05-18 11:25:21	0.15A	1.8 sec						
0.336	2017-05-18 11:25:17	0.22A	1.8 sec						
0.337	2017-05-18 11:25:42	0.21A	1.8 sec						
0.336	2017-05-18 11:25:52	1.50A	2.6 sec						
0.336	2017-05-18 11:27:06								
0.340	2017-05-18 11:27:34								
0.343	2017-05-18 11:27:47								
0.342	2017-05-18 11:27:54								



REMOTE PARAMETERISATION BY MOUSE CLICK

Stun No.	Date/Time	Current	Head/Neck	Time	Head/Neck	Time	Head/Neck	Time	Head/Neck
0		1.4	4 sec						
1		1.8A	6 sec						
2		1A	1.5						

STUN-E4

Stunning device (constant current & high frequency)



Electronic, high-frequency, constant-current stunning device for the craft application suitable for trade

- 4 pre-installed stunning programs, individually adaptable
- Can be extended to up to 24 stunning programs
- LCD display with 40 characters for real time display of program number, current, voltage, frequency and stunning time
- Acoustic and visual display for errors and the end of stunning
- 6 convenient buttons for program selection and programming
- Network-compatible (Ethernet RJ45)
- Web interface with daily/weekly/monthly statistics

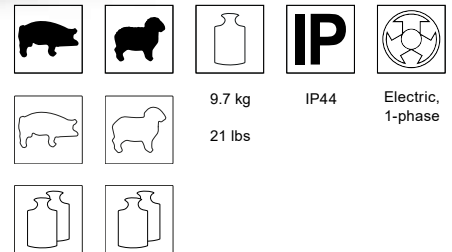

STUN-CHECK-M

Test device for electric stunner

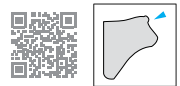

The "STUN-CHECK-M" test device checks the functions and programs (safety and stun functions) of electric stunners.

The STUN CHECK-M is used for checking the stunner, functional testing of individual programs and for checking that the tongs are working correctly (potential cable break or other damage to the tong). This is done in conformity with the legal standards

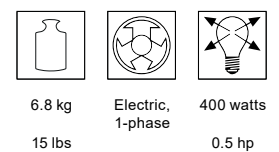



STUN-E-INSPECTION

Inspection package for electric stunners of the FREUND brand

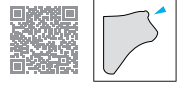

Electrical safety in accordance with DIN VDE 0701/0702/EN60204-1

All our electrical machines are tested for electrical safety prior to commissioning and following modification or repair in our factory by a qualified electrician in accordance with the electrical engineering rules of DIN VDE 0701-0702/EN 60204-1 and a test badge is attached to said machines.

This test badge indicates when the next repeat inspection must take place.

Inspection interval:

The inspection interval for electrical machines and equipment that is used in slaughtering and cutting plants is every six months.

Inspection in accordance with the German Animal Protection Slaughter Regulation (TierSchIV)

With regard to all FREUND electric stunners, all relevant stunning and work safety parameters are inspected prior to initial commissioning in accordance with the applicable German Animal Protection Slaughter Regulation (TierSchIV) and the EC Regulation 1099/2009, the operational safety regulation and the accident prevention regulation.

Regulation (EC) No. 1099/2009 applies to the slaughter and killing of vertebrate animals intended for the production of food and other products. It therefore contains provisions applicable to the slaughter or killing of animals kept for farming. An inspection sticker is attached to the device.

Inspection interval:

This inspection sticker indicates when the next annual repeat test must take place.

A replacement device (STUN-E4, E6XXL or E8XXL) can be made available for the duration of the inspection/test in accordance with the applicable Animal Slaughter Protection Regulation, operational safety regulations and accident prevention regulations.

- You give us a call on +49 5251 1659-0
- We send you a replacement device from the latest generation (premium package subject to an additional charge)
- You send us your device with the tong and we check that it complies with regulations
- Does the unit meet all test requirements, we issue a test sticker and a test certificate
- Does the unit not meet all test requirements, we put together a cost estimate for the repair work
- After the inspection/repair has been completed, you will receive your unit back.
The replacement appliance is collected (premium package subject to a charge).



STUN-BP1

Captive bolt stunner (pneumatic)

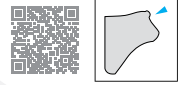

Pneumatic captive bolt stunner for cattle, calves and solipeds

- 2-hand safety switch
- powerful one-shot stunning
- stunning suitable for animal protection
- penetrating

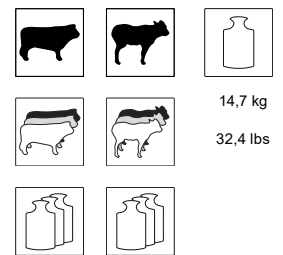

COMP-BP1-1

Compressed air compressor



Compressed air compressor for up to 60 stuns per hour (mobile version on wheels)

- 90L tank
- 850 rpm
- incl. maintenance unit (filter, regulator, lubricator)
- 5 metre hose
- 1L oil
- ready for connection

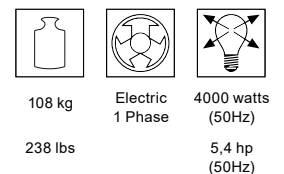

COMP-BP1-2

Compressed air compressor

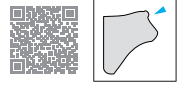

Compressed air compressor for up to 60 stuns per hour
(mobile version on wheels)

- 90L tank
- 850 rpm
- incl. maintenance unit (filter, regulator, lubricator)
- 5 metre hose
- 1L oil
- ready for connection

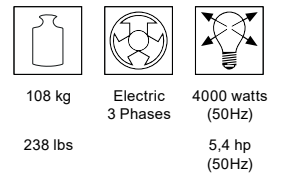

SCHERMER K SERIES

Captive bolt stunner of series K

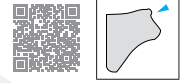

Videos on maintenance & care

Captive bolt stunner in different designs and sizes

- High penetrating power even for high slaughter throughput
- Effective trigger safety system
- Automatic cartridge ejector
- Quick-release bayonet lock
- Low wear thanks to robust design
- Low cleaning and maintenance costs
- Easy handling
- Economical high-performance cartridges, calibre .27 - 6.8/15 mm
- Bears a test mark from the PTB in Braunschweig



SCHERMER KR

Captive bolt stunner with bolt discharge



Captive bolt stunner with bolt discharge for maximum performance.

For pigs, sheep and horses or cattle up to 1000 kg live weight

- Manual bolt return
- Bolt discharge: 85 mm
- Trigger safety system
- Maximum power performance due to undamped bolt discharge
- Only in combination with head fixation
- Calibre .27 - 6,8/15 mm
- PTB tested and certified according to CIP and CE

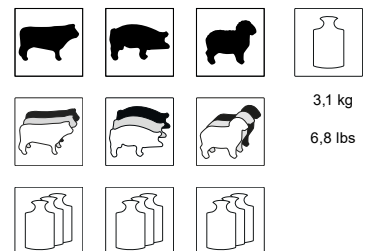

SCHERMER KL

Captive bolt stunner in extended design



Captive bolt stunner in extended design particularly suitable for large animals over 1000 kg live weight such as breeding bulls and water buffaloes as well as for heavy boars

- Manual bolt return
- Bolt discharge: 125 mm
- Trigger safety system
- Elongated design with extra long bolt
- Only in combination with head fixation
- Calibre .27 - 6,8/15 mm
- PTB tested and certified according to CIP and CE

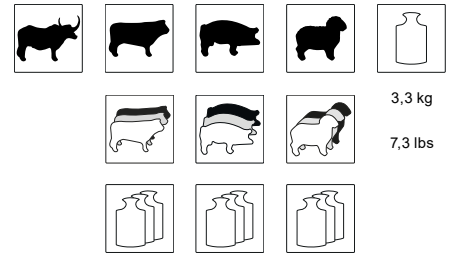

3,3 kg
7,3 lbs

- Design is otherwise the same as that of captive bolt stunner type KR

SCHERMER KS

Captive bolt stunner with automatic bolt retraction system

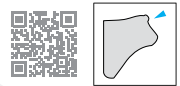

Captive bolt stunner with automatic bolt retraction system for cattle, pigs and sheep up to 650 kg live weight

- Automatic bolt retraction system
- Bolt discharge: 80 - 85 mm
- Trigger safety system
- Calibre .27 - 6,8/15 mm
- PTB tested and certified according to CIP and CE

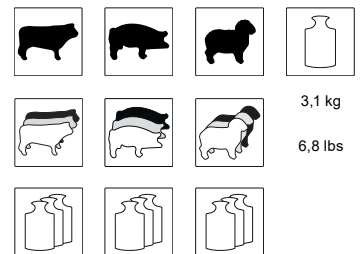

3,1 kg
6,8 lbs

SCHERMER KK

Captive bolt stunner in shortened design

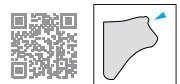

Captive bolt stunner for calves, pigs and sheep up to 650 kg live weight

- Manual bolt return
- Bolt discharge: 75 mm
- Trigger safety system
- Easy handling when space is limited, e.g. for stunning in a transport truck
- Calibre .27 - 6,8/15 mm
- PTB tested and certified according to CIP and CE

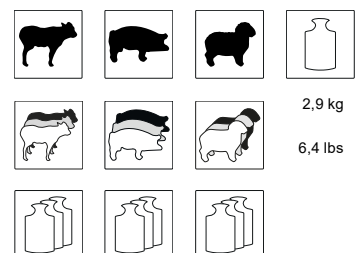

2,9 kg
6,4 lbs

- Design is otherwise the same as that of captive bolt stunner type KR

SCHERMER KC

Captive bolt stunner for concussion stunning



Captive bolt stunner for concussion stunning of cattle, calves and sheep up to 1000 kg live weight

- Non penetrating
- Suitable for Halal slaughter
- Trigger safety system
- Calibre .27 - 6,8/15 mm
- Use may be subject to national regulations and restrictions

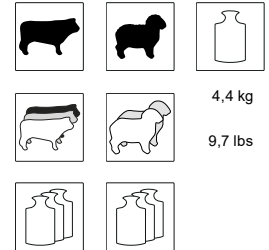

▶ Not permissible for stunning in plants within a member state of the European Union (TierSchIV 1099 vom 01.03.2013)

STUN TEST-GERÄT

Test device for captive bolt stunners



The captive bolt stunners type KR, KL, KK and KS are tested for functionality in the firing mechanism of the test device before slaughter begins.

The bolt firing speed measured by 2 light barriers after triggering the shot is the measured variable for the calculated points.



STUN TESTHÜLSE

Test sleeve for ensuring constant test conditions



The captive bolt stunner is loaded with a test cartridge for the functional test. The test cartridge prevents any unnecessary wear on the captive bolt stunner.

Constant test conditions are ensured by means of the captive bolt stunner inserted in the test sleeve. In this type of proof testing, the shot is fired into square timber. The penetration depth of the bolt is the measured value to be checked.



OPTIONAL

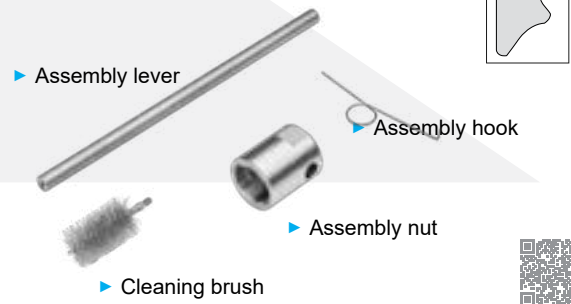

Accessory set for cleaning captive bolt stunners

- Included in the purchase of captive bolt stunners
- Also available as an option

Test cartridges calibre .27 6.8/11 mm

- to check the functionality of livestock shooting devices before the start of slaughter in the STUN test device



High-performance cartridges Cal .27" 6,8/15 mm

When choosing a suitable cartridge strength, consider the following: age, weight, breed, hair coat, skin folds, sex of the animal and any head fixation.



	KR	KS	KK	KL	KC
APPLICATIONS	RECOMMENDED CARTRIDGE CONFIGURATION				
> 1000 kg*	-	-	-		
650 - 1000 kg*		-	-	-	
300 - 650 kg*				-	
< 300 kg*				-	
	-	-	-		
				-	
> 150 kg*		-	-		
30 - 150 kg*				-	
< 30 kg*				-	
				-	
				-	

Observe country-specific legal position

*Specified weight relates to live weight



SLAUGHTERING

SLAUGHTERING

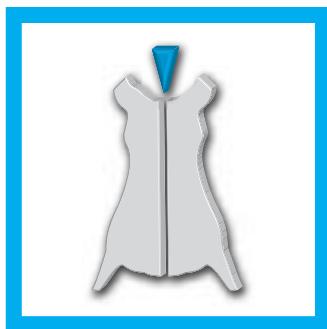













The 'Slaughtering' product group completes the FREUND machine range with the latest technology in meat processing.

These machines are characterised by a robust design coupled with the most important features for optimum, user friendly operation in day-to-day slaughtering activities.

The saws are freely configurable and can be adapted accordingly to the needs of the user.

In technical matters, the FREUND service department will be happy to advise you.

CONTENTS

	Stimulation	30		Breastbone	37-38, 40
	Bleeding	31		Splitting	39 - 43
	Weasand clip	31	▶ Circular saws	39	
	Feet / neck	32	▶ Reciprocating saws	40-41	
	Neck	33	▶ Band saws	42 - 43	
	Horns, legs	34 - 36		Vacuum action	44-51
	Horns	35		Rectum	46
	Dehiding	37	SCHERMER Sprays	52-53	
			Optional accessories	100 - 106	

STIM-E512

Electronic stimulation device (electronical)



Fully programmable stimulation device for medium-sized and industrial companies

- Various programmes for different applications
- Better draining of blood
- Accelerated pH value drop and therefore faster onset of 'rigor mortis'
- Increased yield due to lower weight loss
- Nose clamp & overhead track connection with 10-meter cable

Benefits of low voltage stimulation (<50 Volt):

- Improved product quality

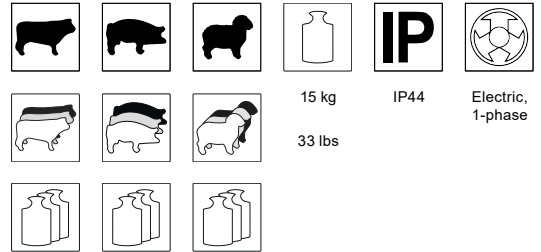

15 kg
33 lbs



IP44



Electric,
1-phase

RÜCKENMARKZERSTÖRER

Cranial insertion rod



A - 900 mm



Use after stunning with captive bolt stunner if no blood withdrawal is planned

- Made from plastic
- Available in two lengths



B - 350 mm

EBH

Sticking knife

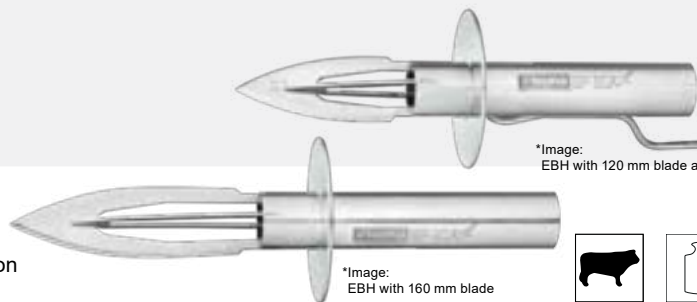

*Image:
EBH with 120 mm blade and tube for anti-coagulator

Sticking knife for hygienic blood extraction

- Blade and blade holder can be easily exchanged
- Cost-effective, modular design

OPTIONAL:

- Blade available in 2 sizes: ▶ 120 mm for sheep/pigs
▶ 160 mm for cattle
- Anti-coagulator tube available for all sizes

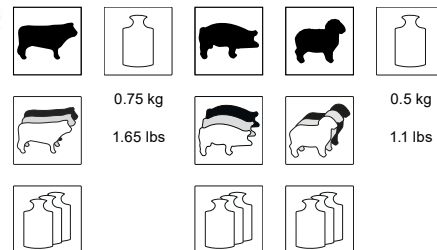

*Image:
EBH with 160 mm blade

WEASAND CLIP

Weasand clip (oesophagus seal)



- Secure and straightforward sealing of the oesophagus prevents contamination by any stomach content being discharged
- Available in two different sizes (sheep and cattle), easy to use even when the oesophagus is full or damaged
- Secure seating: no slipping out of place, no leakage, no premature release
- Bio-degradable plastic (FDA approved)
- Affordable, graduated price scale

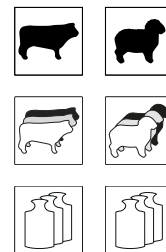

RODDING STAB / WEASAND ROD

Weasand rod

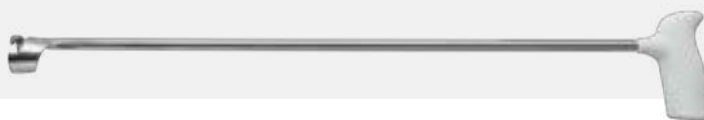

- Made of stainless steel, to ensure correct placement of Weasand clip (oesophagus seal)
- Rod is guided along the esophagus in order to place a clip in front of the cardia
- Prevents the discharge of rumen fluid
- Available in 2 lengths: ▶ 340 mm for sheep
▶ 770 mm for cattle

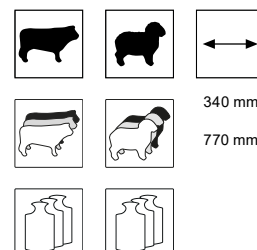

FNS9

Foot and neck shear



Foot and neck shear for pigs and sheep in high throughput plants

- For severing the head joint and removing the feet of halved pigs and sows by an operator
- user-friendly handling
- Also suitable for cutting the front feet of sows
- Perfect force distribution
- Excellent cut

		3.9 kg	90 mm	6 bar	Pneumatic/ hydraulic
		8.6 lbs	3 1/2 inch	87 psi	

► configurable en 4 options :

Option 1 :

- vertical knife position



Option 2 :

- horizontal knife position



Option 3 :

- vertical knife position
- Pistola Handle

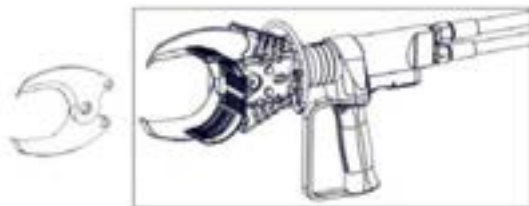

Option 4 :

- horizontal knife position
- Pistola Handle



NS21

Neck shear

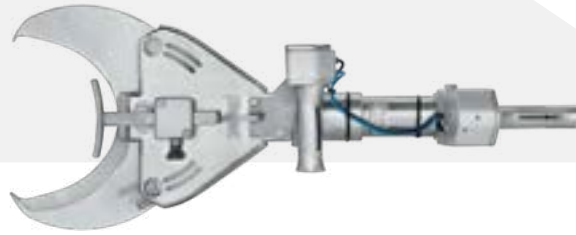

Hydraulic neck shear for pigs in high throughput plants

- Adjustable handle for better ergonomics
- Two-hand safety switch
- with adjustable depth stop
- Excellent force distribution



23 kg
51 lbs

210 mm
8,3 inch

6 bar
87 psi

Electric/
hydraulic



NS26

Neck shear



Hydraulic neck shear for removing the neck of sows & boars in high throughput plants

- Adjustable handle for better ergonomics
- Two-hand safety switch
- with adjustable depth stop
- Excellent force distribution



27 kg
59 lbs

265 mm
10,4 inch

6 bar
87 psi

Electric/
hydraulic



NS26-H1

Neck shear

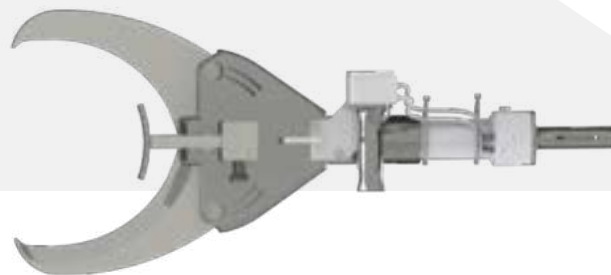

Hydraulic neck shear for removing the neck of sows & boars in high throughput plants

- Adjustable handle for better ergonomics
- Two-hand safety switch
- with adjustable depth stop
- Excellent force distribution



24 kg
53 lbs

265 mm
10,4 inch

6 bar
87 psi

Electric/
hydraulic



HDS15

Head dropper and general cutting shear

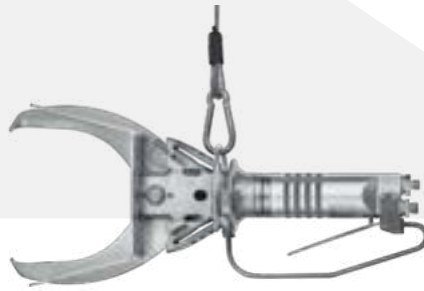

Hydraulic shear for high throughput plants:

- Application in pig cutting
- Severing of complete sheep and goat heads
- Single-hand operation

		5.8 kg	150 mm	6 bar	Electric/hydraulic
		12.8 lbs	6 inch	87 psi	

HLS12

Horn and leg shear

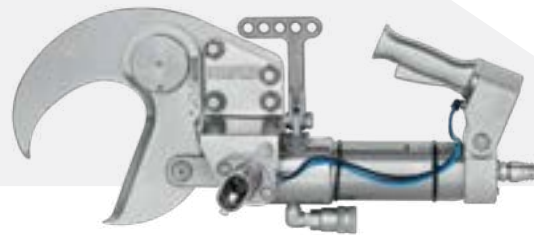

Horn and leg shear for industrial slaughter chains for cattle

- With one fixed and one moveable blade respectively
- Adjustable handle for better ergonomics
- Two-hand safety switch

	26.4 kg	120 mm	3-8 bar	Electric/hydraulic
	58.2 lbs	4 1/2 inch	44-116 psi	

LS15

Leg shear



Leg shear for cattle and sows in high throughput plants

- With two movable blades
- Two-hand safety switch
- Adjustable handles for better ergonomics

		21.6 kg	150 mm	3-8 bar	Electric/hydraulic
		47.6 lbs	6 inch	44-116 psi	

HZ7

Horn cutter

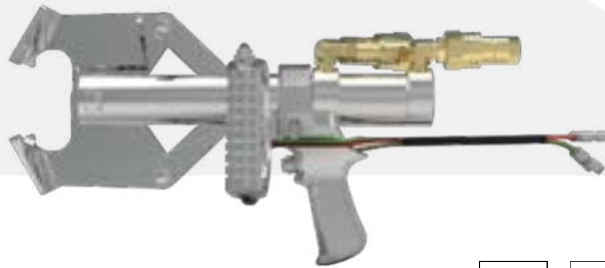

Hydraulic horn cutter for lambs in high throughput plants

- Two-hand safety switch



6 kg

70 mm

3-8 bar

Hydraulic

13 lbs

2 1/2 inch

44-116 psi

HZ10

Horn cutter



Hydraulic horn cutter for sheep in high throughput plants

- Two-hand safety switch



15 kg

100 mm

3-8 bar

Hydraulic

33 lbs

4 inch

44-116 psi



HG12

Horn guillotine



Hydraulic horn guillotine for the most arduous applications in high throughput plants

- Pneumatic 2-hand safety switch



33 kg

120 mm

3-6 bar

Hydraulic

73 lbs

4 1/2 inch

44-87 psi



HBK28-06

Circular horn and leg saw



Circular horn and leg saw for cattle in medium plants

- Mechanical motor brake MMB
- Two-hand safety switch



21 kg
46 lbs

280 mm
11 inch

100 mm
4 inch

IP 65

Electric,
3-phase

1800 watts
(50Hz)
2.4 hp
(50Hz)



HBK33-08

Circular horn and leg saw



Circular horn and leg saw for cattle in high throughput plants

- Two-hand safety switch
- With smooth cable GK



31 kg
68 lbs

330 mm
13 inch

105 mm
4 inch

IP 65

Electric,
3-phase

2300 watts
(50Hz)
3.1 hp
(50Hz)



SD11

Dehider



Pneumatic dehider with star-shaped blades

- Efficient, clean and safe dehiding - avoids incisions, notches or holes
- Durable and low-maintenance
- Low own weight due to lightweight components

			1.4 kg	110 mm	3.5 bar	Pneumatic	410 watts
			3 lbs	4 1/2 inch	51 psi		0.55 hp

BBS14

Breastbone shear



Breastbone shear for sheep and goats in medium and high throughput plants

- with powerful compressed air cylinder
- with second ergonomic handle
- Flexible DL spiral hose 2.5 m

	14 kg	145 mm	7 bar	Pneumatic
	31 lbs	6 inch	102 psi	

BBKM25-06D

Circular brisket knife



21 kg
46 lbs

250 mm
10 inch

85 mm
3 1/2 inch

IP 65

Electric,
3-phases

1800 Watt
(50Hz)
1.8 hp
(50Hz)



Circular brisket knife for slaughtering pigs and sheep in medium and high throughput plants

Benefits of the micro-serrated circular knife:

- Optimised hygiene and longer service life
- Clean and smooth blade cut
- Spiral cable SK
- Round handle R (D type)
- Special blade protection prevents organ cutting

OPTIONAL:

- Upright rear handle for working position at belly height or higher



SK32-06L

Circular splitting saw



Circular splitting saw for slaughtering pigs and sheep in medium plants (without head)

- Mechanical motor brake MMB
- Circular saw blade, coarse tooth, rust-free KGZ320
- Spiral cable SK
- Upright handle on gear neck GH
- Water connection with spiral hose for cooling and rinsing the cutting surface



19 kg

320 mm

120 mm

IP 65

Electric,
3-phases

1800 watts
(50Hz)
2.4 hp
(50Hz)



42 lbs

12 1/2 inch

4 1/2 inch



SK52-08L

Circular splitting saw



Circular splitting saw for slaughtering pigs in high throughput plants (sows to some extent)

- Circular saw blade, coarse tooth, splitting, low-noise, rust-free KGZ520SPGA
- With smooth cable GK
- Two-hand safety switch
- Water connection with spiral hose for cooling and rinsing the cutting surface
- With 2 guide rollers for splitting from the rear



41 kg

520 mm

205 mm

IP 65

Electric,
3-phases

2300 watts
(50Hz)
3.1 hp
(50Hz)



90 lbs

20 1/2 inch

8 inch



BBST30-13

Reciprocating breastbone saw



Reciprocating breastbone saw for slaughtering cattle & sows in small and medium plants

- Reciprocating saw blade, fine tooth, rust-free
- Spiral cable SK
- Round handle R (D type)
- Grease gun, filled
- Low dead weight

			12.3 kg	300 mm	IP 65	Electric, 3-phases	950 watts (50Hz)
			27 lbs	12 inch			1.3 hp (50Hz)

BBH30-03

Reciprocating breastbone saw

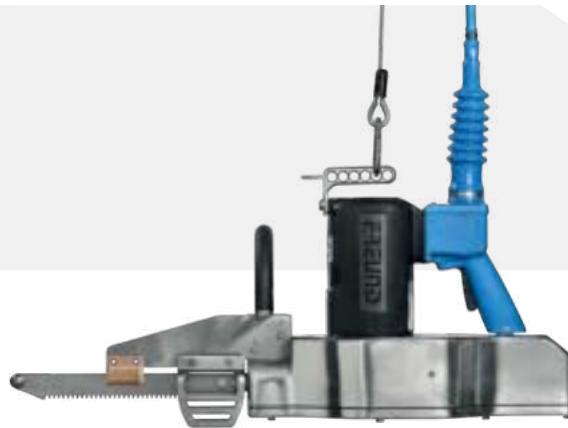

Reciprocating breastbone saw for slaughtering cattle and sows in all plants sizes

- Reciprocating saw blade, rust-free
- Spiral cable SK
- Round handle R (D type)
- Grease gun and 1 kg grease
- Control box, mounted

			21.5 kg	300 mm	IP 65	Electric, 3-phases	1300 watts (50Hz)
			47 lbs	12 inch			1.8 hp (50Hz)

SST50-13

Reciprocating splitting saw

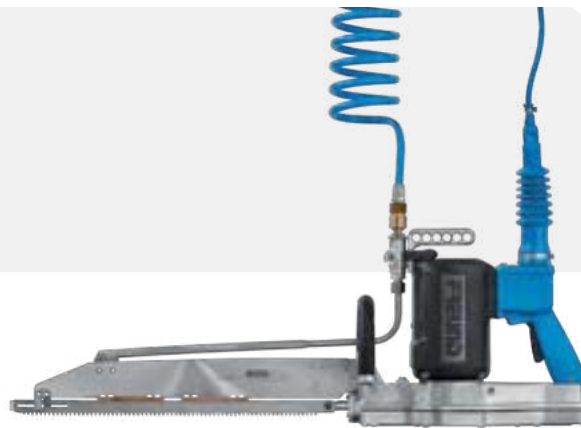

Reciprocating splitting saw for up to 2 cattle, 15 pigs or 50 sheep per week

- Suitable for trade
- Smallest reciprocating splitting saw of its kind with a completely enclosed three-phase motor
- Low dead weight
- Saw blade made of rust-free steel STFZ 500 mm
- Spiral cable SK
- Round handle R (D type)
- Gun with special grease

		11.5 kg	500 mm	IP 65	Electric, 3-phases	950 watts (50Hz)
		25 lbs	20 inch			1.3 hp (50Hz)

SH60-03

Reciprocating splitter saw



Reciprocating splitter saw for halving up to 100 pigs or 20 cattle per week

- Suitable for trade
- Reciprocating saw blade, coarse tooth, rust-free HUGZ600SP
- Spiral cable SK
- Round handle R (D type)
- Direct connection to contactor/transformer
- Water connection with spiral hose for cooling and rinsing the cutting surface
- including grease gun

			21.6 kg	600 mm	IP 65	Electric, 3-phases	1300 watts (50Hz)
			47.6 lbs	23 1/2 inch			1.8 hp (50Hz)

SB46-08

Splitter band saw



Splitter band saw for pigs/sheep (high throughput plants) and cattle (medium plants) in a combination slaughter line

- If using a low gambrel, halving of pigs is only possible with restrictions (in such cases SB49-08)

					IP		
			64 kg 141 lbs	460 mm 18 inch	IP 65	Electric, 3-phase	2300 watts (50Hz) 3.1 hp (50Hz)

SB49-08

Splitter band saw



- Particularly suited to expansion brace slaughtering due to the low height (front: 300mm)
- Splitting of cattle is only possible with limitations for this reason

				IP		
		64 kg 141 lbs	490 mm 19 1/2 inch	IP 65	Electric, 3-phase	2300 watts (50Hz) 3.1 hp (50Hz)

SB50-08

Splitter band saw

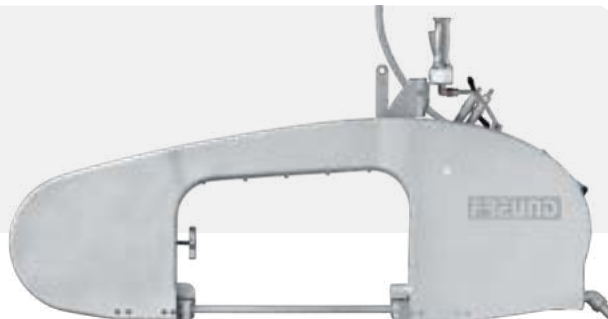

Splitter band saw for cattle and sows in high throughput plants

				IP		
		74 kg 163 lbs	500 mm 19 1/2 inch	IP 65	Electric, 3-phase	2300 watts (50Hz) 3.1 hp (50Hz)

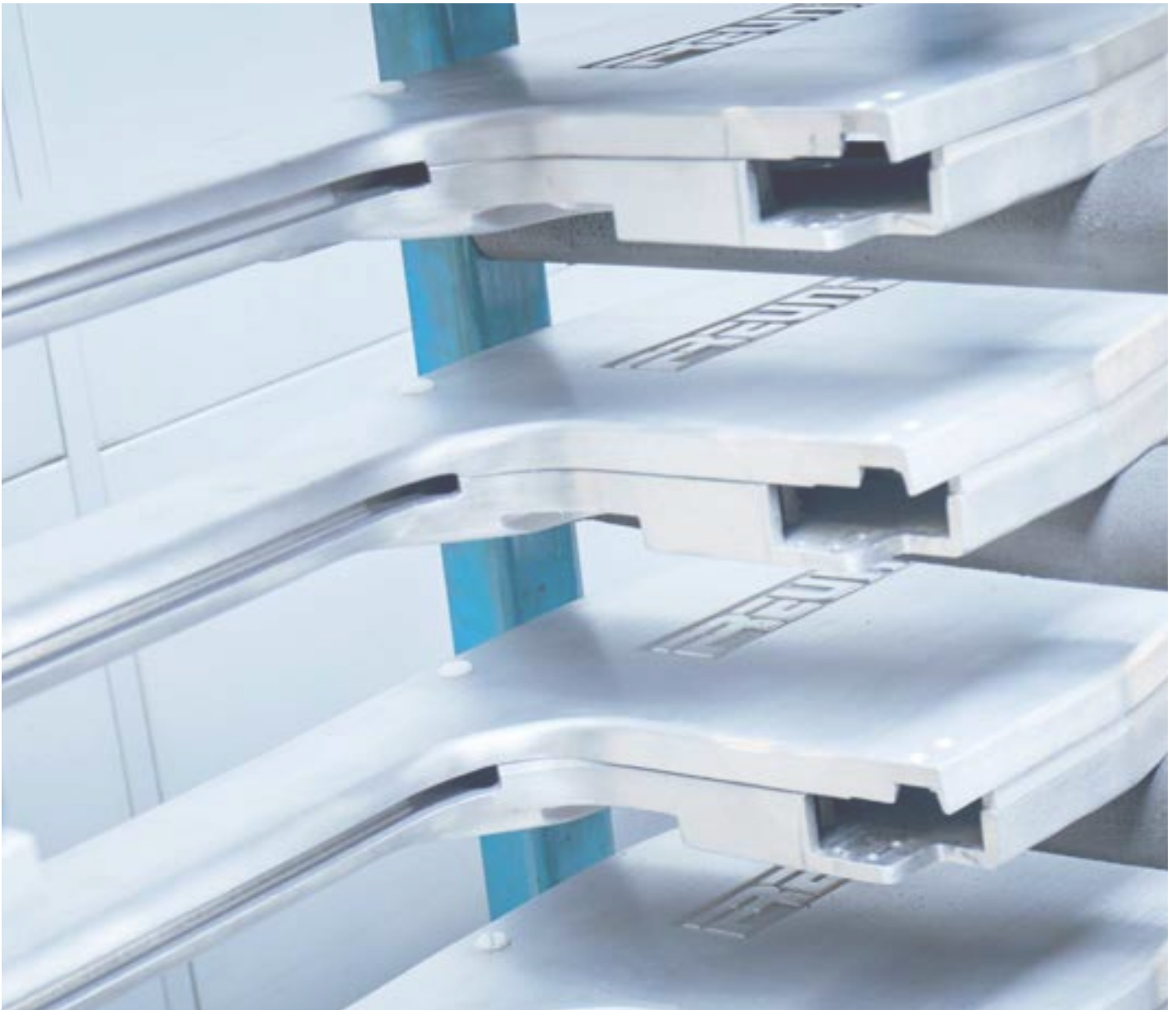

All BASIC models of SB46-08 / SB49-08 / SB50-08 are fitted with the following STANDARD equipment:

- Manual blade tensioning system MAN with lever blade guides HF
- Machine safety switch (cover sensor) MSS
- Water hose unit
- Inbuilt disinfection system DES-E
- 5 replacement saw blades

BOOKABLE AS OPTIONAL EXTRAS for standard equipment:

- Automatic tensioning system (hydraulic) for rapid band saw blade exchange and optimum blade tension at all times AUT with automatic band saw blade rotation for rapid band saw blade exchange with adjustable blade guides JF
- Two-hand safety switch 2HATD
- DES-PO7 inbuilt disinfection kit

SVSS

Steam vacuum sanitizer system



SVSS

Steam vacuum sanitizer system



or efficient elimination of contamination and reduction of surface germ counts on carcasses

- Vacuum suctioning of contamination such as bowel contents, hair
- Simultaneous disinfection of the surface using steam
- Significantly better germ reduction compared to cutting with blades e.g. in relation to E.coli bacteria
- Greater food safety
- Increased yield due to lower weight loss compared to trimming
- Reduced risk of cross-contamination thanks to continuous steam disinfection of the hand piece
- No visible change to the surface of the meat

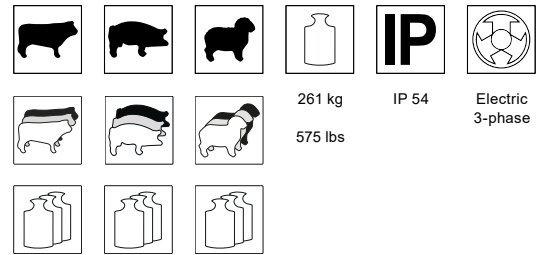

OPTIONAL:

- ▶ Steam generator SVG21
- ▶ Steam generator SVG28

SVH-38A

Steam vacuum piece



- Disinfection by means of an integrated steam supply and suctioning by means of a vacuum suction line
- Component of the SVSS

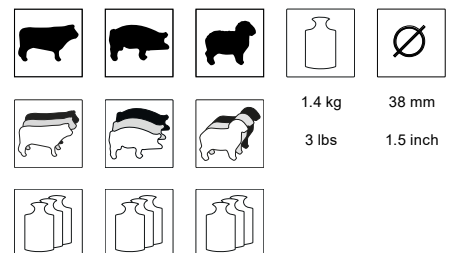

VSS

Vacuum system



Vacuum suction system for vacuum suctioning of spinal cord, brain, leaf lard and grease residues, lungs of poultry etc.

- The equipment can be combined individually and consists of:
- Vacuum tank (rust-free - in different sizes)
- Various hoses
- Hand pieces for different applications
- Vacuum pump optionally available

Optionally also available as version:

- VSS-EDF, specifically for use with rectum cutter EDF64 or EDF76
- VSS-SCR, specifically for use with spinal cord remover-trimmer SCR



*Image similar

EDF

Rectum cutter



To optimally cut out the rectum of pigs and sows.

- Clean and even cut of the rear ham
- Increased yield thanks to more meat on the carcass, on the ham and less on the rectum
- Vacuum extraction of the faecal remains reduces the risk of contamination if the rectum falls into the abdominal cavity
- Internal cleaning system for blades reduces cross-contamination
- ▶ Available in various knife sizes



3.5 kg
7.7 lbs

6 bar
87 psi

Pneumatic

750 watts
1 hp



VSS-VH38B

Hand piece for VSS vacuum suction system (optional)



Vacuum suction system hand piece with scraping edge
for removing the spinal cord (from the halved carcass) of cattle, pigs and sheep

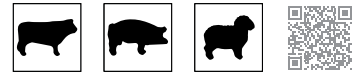

VSS-VH38G

Hand piece for VSS vacuum suction system (optional)



Suction handpiece with 2.2 m hose
for removing the spinal cord of cattle with the carcass closed



VSS-VH38H

Hand piece for VSS vacuum suction system (optional)



Vacuum suction system hand piece with scraper mandrel
for removing the spinal cord (from the halved carcass) of cattle, pigs and sheep



VSS-VH38E-2106

Hand piece for VSS vacuum suction system (optional)

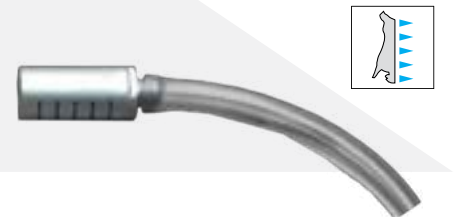

Suction handpiece with 1.2 m hose
for removing the spinal cord of lambs/sheep with the carcass closed



VSS-VH38I

Hand piece for VSS vacuum suction system (optional)



Vacuum suction system hand piece with extended nozzle
for removing the spinal cord (from the halved carcass) of cattle, pigs and sheep

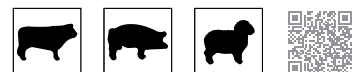

MODULAR DESIGN

Trimmer_evo3 with vacuum extraction - Examples of modular design



NEW!

= Trimmer 35_evo3
▲ variant SCR
spinal cord remover



= Trimmer 35_evo3
▲ variant with
vacuum extraction



= Trimmer 35_evo3



= Trimmer 52_evo3
variant with vacuum extraction



= Trimmer 52_evo3



Exploded views of
Trimmer_evo3 / electrical

► More information on the TM-E6000_evo3 motor and the modular design of Trimmer_evo3 can be found on pages 75-77

► Electric motor TM-E6000_evo3



TRIMMER 35_evo3

Trimmer 35_evo3 - variant SCR spinal cord remover



NEW!

- Ergonomic handle
- New flexible suction and delivery hose
- 2 ring blade sizes available:
 - ▶ SCR16 for pigs
 - ▶ SCR19 for cattle
- One-hand control with the latest start-stop system
- Suitable for right & left-handed users

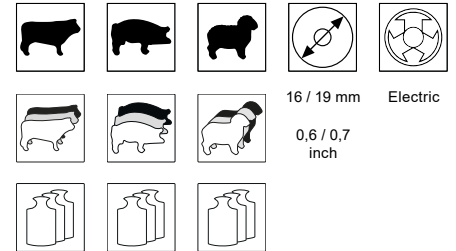

TRIMMER 35_evo3

Trimmer 35_evo3 - variant with vacuum suction



NEW!

- Ergonomic handle
- New flexible suction and delivery hose
- Ring blade types 35A or 35B for almost any application with vacuum extraction
- One-hand control with the latest start-stop system
- Suitable for right & left-handed users

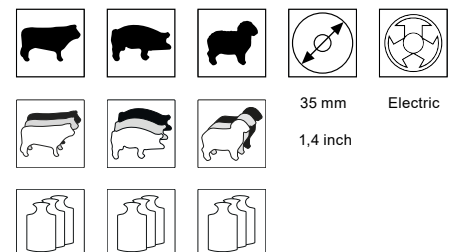

TRIMMER 52_evo3

Trimmer 52_evo3 - variant with vacuum suction

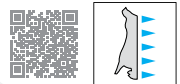

NEW!

- Ergonomic handle
- New flexible suction and delivery hose
- Ring blade types 52A or 52B for almost any application with vacuum extraction
- One-hand control with the latest start-stop system
- Suitable for right & left-handed users

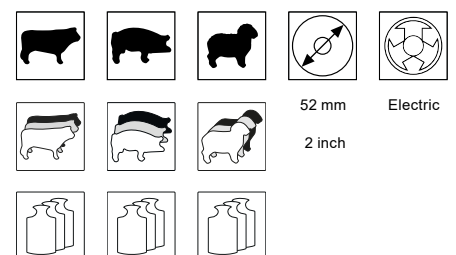

TRIMMER 35

Trimmer 35 - variant spinal cord remover SCR



- The modern way of removing spinal cord in which the risk material is completely isolated
- The spinal cord strand is suctioned by means of a vacuum (VSS vacuum system = accessories). The internal cutting edge separates the spinal cord without harming the spinal cord skin
- 2 ring blade sizes available:
 - ▶ SCR16 for pigs
 - ▶ SCR19 for cattle

		16 / 19 mm	6 bar	Pneumatic	280 watts
		0.6 / 0.7 inch	87 psi		0.3 hp

TRIMMER 35

Trimmer 35 - variant with vacuum suction



- Application-optimised design
- Various blade types (straight ring blade, hook ring blade)
- Minimal downtime and servicing costs thanks to low-wear quality components
- Ergonomic handle with robust and abrasion-resistant plastic design
- Quiet operation minimises vibrations on the hand piece
- Optionally powered electrically or pneumatically

			35 mm	Electric or pneumatic	250 watts
			1.4 inch		

TRIMMER 52

Trimmer 52 - variant with vacuum suction



- Application-optimised design
- Easy handling thanks to spherical suction head
- Various blade types (straight ring blade, hook ring blade)
- Minimal downtime and servicing costs thanks to low-wear quality components
- Ergonomic handle with robust and abrasion-resistant plastic design
- Quiet operation minimises vibrations on the hand piece
- Optionally powered electrically or pneumatically

			52 mm	Electric or pneumatic	250 watts
			2 inch		

TRIMMER

Ring blade selection & application



RING BLADE SELECTION



■ A (straight)

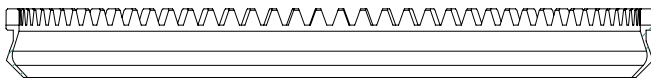
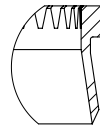

■ B (hook)

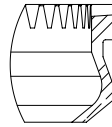

FOR SPINAL CORD REMOVAL

■ SCR16

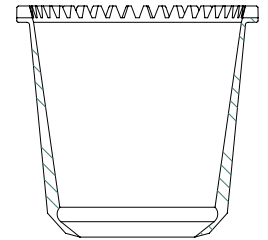

■ SCR19

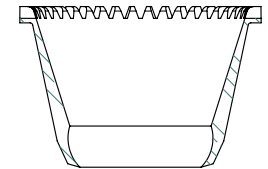

APPLICATION

SLAUGHTERING	Ø 35 mm	Ø 52 mm	CUTTING	Ø 35 mm	Ø 52 mm
Trimming / vacuum suctioning tonsils in head	A		Trimming / vacuum suctioning auricles	A	
Trimming / vacuum suctioning spinal hole	A	A	Trimming / vacuum suctioning eyes	A	
Cleaning / vacuum suctioning carcasses	A		Cleaning / vacuum suctioning bones	A	
Trimming / vacuum suctioning cover fat	A	B	Deboning / vacuum suctioning long bones	A	
Trimming / vacuum suctioning chest fat	B		Removing tendons in the shoulder		B
Removing / trimming heart fat		B			
Trimming / vacuum suctioning spinal cord	B	B			
Trimming / vacuum suctioning blood vessels	B	A / B			
Trimming / vacuum suctioning leaf lard	B	B			
Trimming / vacuum suctioning filets		B			

BRAUSE

Spray Model "D"

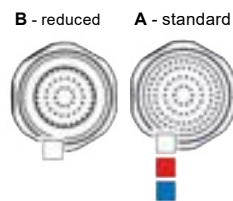
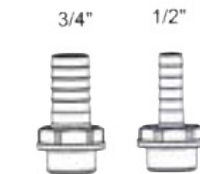

SCHERMER Sprays for the food industry, agriculture and horticulture.

- High-quality processing and robust design
- Economical water consumption due to quick fastener
- Max temperature 90°C*
- Max. water pressure 6 bar

0,4 kg	180 mm	44 mm
0,9 lbs	7 inch	1,7 inch

* Food-safe plastic complies with Regulation 10/2011 and metal connections comply with the drinking water ordinance (Trinkwasserverordnung)

Colourcode: Plastic white Plastic red Plastic blue Metal

DESIGNS OF Model "D"

HOUSING									
CONNECTION	1/2	3/4	-	1/2	3/4	-	1/2	3/4	-

VALVE	SCREEN									
	<input type="checkbox"/>	A / B	A / B	A / B	A	A	A	A	A	A
	<input type="checkbox"/>	A	A	A	A	A	A	A	A	A
	<input type="checkbox"/>	A	A	A	A	A	A	A	A	A
	<input type="checkbox"/>	A / B	A / B	A / B	A	A	A	A	A	A
	<input type="checkbox"/>	A	A	A	A	A	A	A	A	A
	<input type="checkbox"/>	A	A	A	A	A	A	A	A	A

BRAUSE

Spray Model "E"



SCHERMER spray with adjustable spray nozzle for the food industry, agriculture and horticulture

- High-quality processing and robust design
- Adjustable water outlet for jet or spray
- Max temperature 90°C*
- Max. water pressure 6 bar

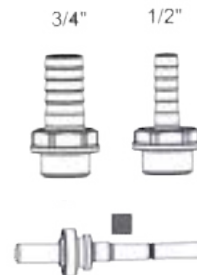

0,6 kg	205 mm	6 mm
1,3 lbs	8 inch	0,23 inch

BRAUSE

Spray Model "F"



SCHERMER spray with spray nozzle for the food industry, agriculture and horticulture

- High-quality processing
- Efficiently bundled jet
- Max temperature 90°C*
- Max. water pressure 6 bar – diameter 5 mm

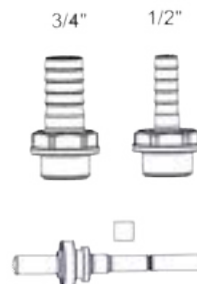

0,5 kg	220 mm	4,8 mm
1,1 lbs	8,7 inch	0,18 inch

BRAUSE

Spray Model "H"



SCHERMER spray with elongated nozzle for the slaughtering industry

- High-quality processing
- Max temperature 90°C*

Max. water pressure 6 bar

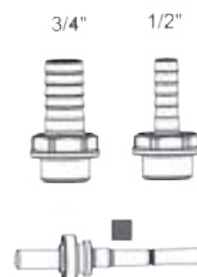

0,8 kg	365 mm	15 mm
1,8 lbs	14,4 inch	0,6 inch

* Food-safe plastic complies with Regulation 10/2011 and metal connections comply with the drinking water ordinance (Trinkwasserverordnung)



PRIMAL CUTTING

PRIMAL CUTTING

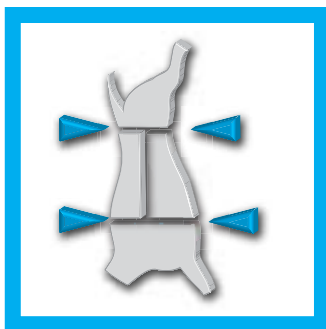



FREUND circular breaking and quartering saws offer state-of-the-art technology of the highest quality.

Tailored to each application, the individual products provide the right configuration for every kind of processing.

Safety and flexibility when handling saws is just as much at the core of this product group as high-quality processing.

The FREUND service department supports the user by offering expert advice in all technical matters relating to the individual machines.

CONTENTS

	Quartering	56-58		Cutting	59 - 71
	▶ Shears	56		▶ ZKM - Circular cutting knife - Tabletop version	59
	▶ Breaking saws	56 - 57		▶ ZKM - Circular cutting knife as a modular table version	60 - 61
	▶ Circular saws	58		▶ ZKM - Circular cutting knife	62 - 65
				▶ Circular saws	66 - 69
				▶ Rib Cutter	70 - 71
				Optional accessories	100 - 106

AS28

Quartering shear



Hydraulic shear for quartering cattle

- Clean and smooth cut through the backbone and back muscles
- Two-hand safety switch
- Adjustable handle for better ergonomics



32 kg

280 mm

6 bar

Hydraulic

71 lbs

11 inch

87 psi



ST40-13

Quartering breaking saw



- Smallest machine of its kind with a completely enclosed three-phase motor
- Breaking saw blade, fine tooth STFZ
- Spiral cable SK
- Round handle R (D type)
- Low-vibration operation thanks to the counterweights installed



12.7 kg

400 mm

IP 65

Electric,
3-phases

950 watts
(50-60Hz)
1.3 hp
(50-60Hz)

28 lbs

15 1/2 inch



ST30-11S

Quartering breaking saw



- Breaking saw blade, fine tooth STFZ
- Spiral cable SK
- Round handle R (D type)
- Low-vibration operation thanks to the counterweights installed
- High speed (S)
- Due to the low dead weight of the machine, no spring balancer is mandatory.

			6.5 kg	300 mm	IP 24	Electric, 1-phase	860 watts (50-60Hz)
			14 lbs	12 inch			1.17 hp (50-60Hz)

ST40-11S

Quartering breaking saw



- Breaking saw blade, fine tooth STFZ
- Spiral cable SK
- Round handle R (D type)
- Low-vibration operation thanks to the counterweights installed
- High speed (S)

			7.4 kg	400 mm	IP 24	Electric, 1-phase	860 watts (50-60Hz)
			16.3 lbs	15 1/2 inch			1.17 hp (50-60Hz)

K28-06L

Quartering and circular breaking saw



Quartering and circular breaking saw for general cutting work in high throughput plants

- Long gear neck as a second handle
- Mechanical motor brake MMB
- Circular saw blade, coarse tooth, rust-free KGZ
- Spiral cable SK

OPTIONAL:

- Two-hand safety switch

				IP		
	19 kg	280 mm	100 mm	IP 65	Electric, 3-phase	1700 watts (50Hz)
	42 lbs	11 inch	4 inch			2.4 hp (50Hz)

K32-06L

Quartering and circular breaking saw

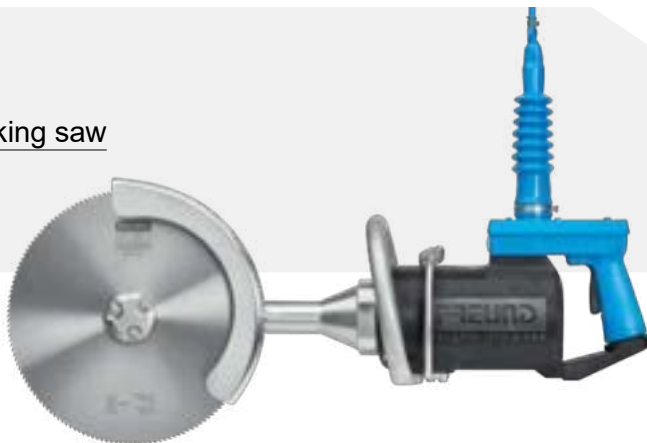

Circular quartering saw for general cutting work in high throughput plants

- Long gear neck as a second handle
- Mechanical motor brake MMB
- Circular saw blade, coarse tooth, rust-free KGZ
- Spiral cable SK

OPTIONAL:

- Two-hand safety switch

				IP		
	19 kg	320 mm	120 mm	IP 65	Electric, 3-phase	1700 watts (50Hz)
	42 lbs	12 1/2 inch	4 1/2 inch			2.4 hp (50Hz)

ZKM25-13PC

Circular cutting knife - Tabletop version



Designed for cutting poultry (chicken, fowl, turkey), small game and small pieces of pig, sheep and calf.

- Optimum ergonomics thanks to open work area on both sides
- Space-saving design with motor above the working area

- Stable bevel gear with lasting durability for the circular breaking saw
- Safety devices and hygiene standard according to CE standard
- Completely enclosed three-phase motor (IP65)



33 kg

250 mm

75 mm

IP 65

Electric,
3-phase

950 watts
(50Hz)/VA
1.3 hp
(50Hz)



73 lbs

10 inch

3 inch



ZKM75-T

Circular cutting knife as a modular table version



4.1



4.2



2.1 (2.2)

3.1

3.2



5.1



5.1



6.1



6.1

ZKM75-T

Circular cutting knife as a modular table version



Circular cutting knife for low-loss coarse cutting of horizontal carcasses, e.g. on a cutting belt conveyor. Also suitable for halving sheep.

- Compact unit for pre-head positioning in advance of a pig/sheep cutting line
- Loss-free, cleaner and hygienic cut without any smearing
- One operator can coarse cut up to 160 pig halves (3 cuts) per hour
- Design: Table with modular, exchangeable roller frame
- Stainless steel circular knife blade ****INOX / rust-free****



300 kg

750 mm

300 mm

IP 65

Electric,
3-phases

2300 watts
(50Hz)
3.1 hp
(50Hz)



661 lbs

29 1/2 inch

12 inch



Pos.	Designation
1	ZKM75-08-T basic model
2.1	KM750S-1F circular knife for pigs
2.2	KM750S-2F circular knife for sheep
3.1	Guide insert for pigs
3.2	Guide insert for sheep
4.1	ZKM-T roller conveyors (left/right)
4.2	ZKM-T roller conveyors with conveyor belts (left/right)
5.1	Roller table attachment RTA
6.1	Buffer roller conveyor RTA

Page 65 Modular circular foot saw FK40-08 for lateral attachment

ZKM75-DA

Circular cutting knife



Circular cutting knife for low-loss coarse cutting of horizontal carcasses, e.g. on a cutting belt conveyor

- Manual lifting of the blade up to 200 mm above the cutting belt
- Space-saving suspension of ceiling or frame structure (suspended installation) in cutting equipment
- Optionally available with powerful motors:
 - 08 (2300 watts) / 190 rpm
 - 46 (3000 watts) / 190 rpm

					IP		
		140 kg	750 mm	300 mm	IP 65	Electric, 3-phase	2300 watts (50Hz) 3.1 hp (50Hz)
		309 lbs	30 inch	12 inch			
							3000 watts (50Hz) 4 hp (50Hz)

ZKM75-DA-JHS

Circular cutting knife



Circular cutting knife for low-loss coarse cutting of horizontal carcasses, e.g. on a cutting belt conveyor

- Height adjustable up to 200 mm via the cutting belt
- Space-saving suspension of ceiling or frame structure (suspended installation) in cutting equipment
- With lateral movement option
- Optionally available with powerful motors:
 - 08 (2300 watts) / 190 rpm
 - 46 (3000 watts) / 190 rpm

					IP		
		200 kg	750 mm	300 mm	IP 65	Electric, 3-phase	2300 watts (50Hz) 3.1 hp (50Hz)
		440 lbs	30 inch	12 inch			
							3000 watts (50Hz) 4 hp (50Hz)

ZKM60-DA-MS

Middle splitter circular knife blade



Circular knife blade for optimum separation of pig mid-sections in belly & cutlet series

- Space-saving suspension of ceiling or frame structure (suspended installation) in cutting equipment
- Continuous cutting angle adjustment $\pm 15^\circ$ can be set for optimum yield
- ▶ Optionally available with powerful motors:
 - 08 (2300 watts) / 190 rpm
 - 46 (3000 watts) / 190 rpm

					IP		
		120 kg	600 mm	175 mm	IP 65	Electric, 3-phase	2300 watts (50Hz) 3.1 hp (50Hz)
		265 lbs	23 1/2 inch	7 inch			3000 watts (50Hz) 4 hp (50Hz)

ZKM95-DA

Circular cutting knife



Circular cutting knife for low-loss coarse cutting of horizontal carcasses, e.g. on a cutting belt conveyor

- Space-saving suspension of ceiling or frame structure (suspended installation) in cutting equipment
- Motor in stainless steel housing with fan cooling
- Large saw blade with a diameter of 950 mm
- Cutting depth of the circular knife blade is 340 mm
- Powerful motor (3000 watts)

					IP		
		210 kg	950 mm	340 mm	IP 65	Electric, 3-phase	3000 watts (50Hz) 4 hp (50Hz)
		485 lbs	37 inch	13 inch			

UNI-PORTAL UP3

Universal portal frame

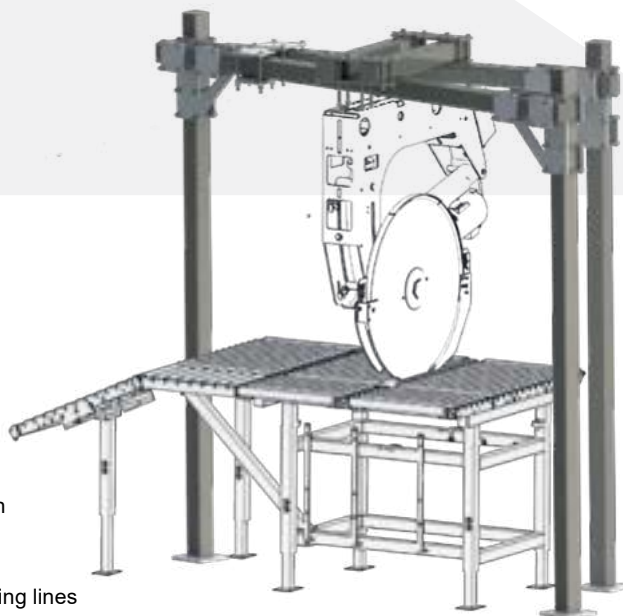

Universally combinable frame design

- for ZKM circular breaking knife and other machines
- Diverse configuration options thanks to the modular design
- Straightforward adjustment of dimensions on-site

For easy set-up or integration of circular knife blades in cutting lines for example:

- ZKM75-DA
- ZKM60-DA-MS

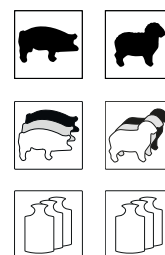

ZKM-T-2CB

Cutting table with automatic discharge conveyor (foldable)



Space-saving cutting table with automatic discharge conveyor, suitable for use with ZKM60-DA-MS

- Space-saving 1x1 design principle (1000x1000 mm work surface)
- Effortless cleaning thanks to table modules at the side that can be folded up/down
- Optimised installation options thanks to easily accessible drum motors and optimised chain link belts, thereby significantly reducing installation time
- Enhanced flushing of the chain link belts
- Automatic outward conveyance of the product
- Tailored to ceiling-suspended ZKM-DA-MS and portal solutions

UNI-PORTAL UP4

Universal portal frame

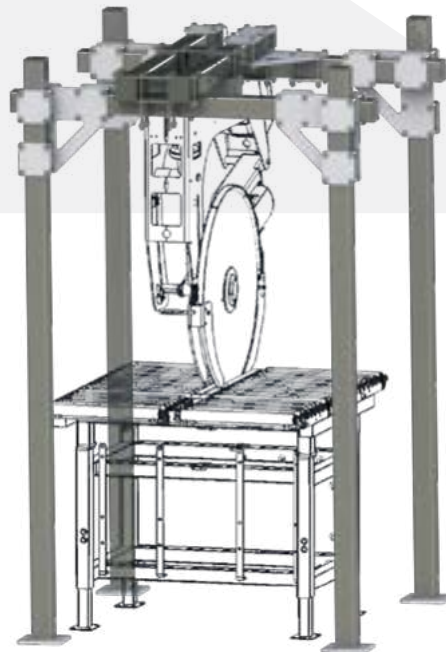

Universally combinable frame design

- for ZKM circular breaking knife and other machines
- Diverse configuration options thanks to the modular design
- Straightforward adjustment of dimensions on-site

For easy set-up or integration of circular knife blades in cutting lines for example:

- ZKM75-DA
- ZKM60-DA-MS

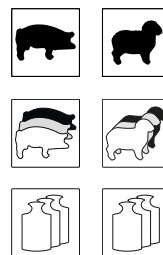

FK40-08

Circular foot saw



Circular foot saw for lateral attachment of cutting equipment

- Circular saw swivel-mounted on the tabletop for optimum cleaning
- Completely encased, powerful bevel gear drive: specifically designed for use in cutting up
- Stable stainless steel design **INOX / rust-free **
- Left and right-hand version available respectively for installation on a table or belt (please specify)
- Including electronic motor brake
- Up to 1200 cuts per hour

		58 kg	400 mm	125 mm	IP 65	Electric, 3-phase	2300 watts (50Hz)/VA
		128 lbs	16 inch	5 inch			3.1 hp (50Hz)

- Saw blade revolutions: 1170/min
- Cutting speed: 1470 m/min.

K16-P4_evo2

Circular breaking saw



Circular breaking saw for universal use

- Adjustable depth control
- Powerful 800W pneumatic- motor "Made in Germany"
- Stainless steel blade guard & depth control
- Even balance and force transmission protects the wrist joints
- Robust and low-wear gear unit
- Adjustable handle for better ergonomics

	3.1 kg	160 mm	15-51 mm	6 bar	Pneumatic
	7 lbs	6 1/2 inch	0.6-2 inch	87 psi	

K18-01

Circular breaking saw



Circular breaking saw for general cutting work in medium plants

- Suitable for trade
- Integrated electronic motor brake (standstill in less than 3 seconds)
- Adjustable depth control
- Round handle R (D type)
- Spiral cable SK

						IP		
			6.3 kg	180 mm	15-65 mm	IP 24	Electric, 1-phase	1050 watts (50-60Hz)
			14 lbs	7 inch	1/2 -2 inch			1.4 hp (50-60Hz)

K18-13

Circular breaking saw



Circular breaking saw for general cutting work in medium plants

- Integrated electronic motor brake (standstill in less than 3 seconds)
- Adjustable depth control
- Round handle R (D type)
- Spiral cable SK

						IP		
			11.5 kg	180 mm	15 - 65 mm	IP 65	Electric, 3-phase	950 watts (50-60Hz)
			25.4 lbs	7 inch	1/2 - 2 inch			1.3 hp (50-60Hz)

K23-03

Circular breaking saw



Circular breaking saw for general cutting work in medium plants

- Adjustable depth control 15-75 mm
- Mechanical motor brake MMB
- Saw blade stop within 3 seconds after switch-off (EU standard)
- Circular saw blades available in various designs
- Round handle R (D type)
- Spiral cable SK

						IP		
			14.5 kg	230 mm	15 - 75 mm	IP 65	Electric, 3-phase	1300 watts (50-60Hz)
			32 lbs	9 inch	1/2 - 3 inch			1.8 hp (50-60Hz)

K23-06

Circular breaking saw



Circular breaking saw for general cutting work

- Adjustable depth control
- Mechanical motor brake MMB
- Saw blade stop within 3 seconds after switch-off (EU standard)
- Circular saw blades available in various designs
- Round handle R (D type)
- Spiral cable SK

						IP		
			19 kg	230 mm	15 - 75 mm	IP 65	Electric, 3-phase	1800 watts (50Hz)
			42 lbs	9 inch	1/2 - 3 inch			2.4 hp (50Hz)

K28-06

Circular breaking saw



Circular breaking saw for general cutting work

- Saw blade stop within 3 seconds after switch-off (EU standard)
- Mechanical motor brake MMB
- Circular saw blades available in various designs
- Round handle R (D type)
- Spiral cable SK

			19.5 kg	280 mm	100 mm	IP 65	Electric, 3-phase	1800 watts (50Hz) 2.4 hp (50Hz)
			43 lbs	11 inch	4 inch			

K32-06

Circular breaking saw

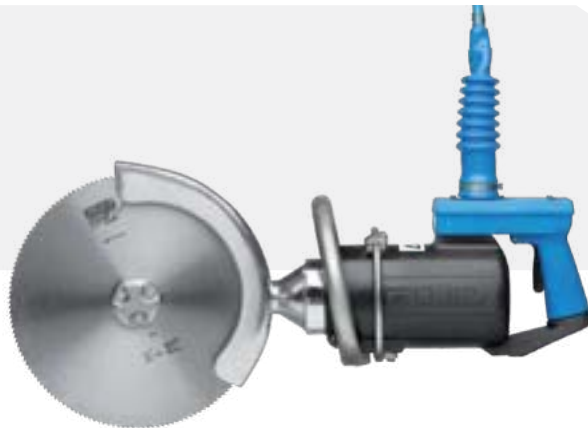

Circular breaking saw for general cutting work

- Saw blade stop within 3 seconds after switch-off (EU standard)
- Mechanical motor brake MMB
- Circular saw blades available in various designs
- Round handle R (D type)
- Spiral cable SK

			20 kg	320 mm	120 mm	IP 65	Electric, 3-phase	1800 watts (50Hz) 2.4 hp (50Hz)
			44 lbs	12 1/2 inch	4 1/2 inch			

RTK18-13

Rib top circular saw



For separating the loin ribs of the spinal column on the complete mid-section

Two adjustable depth stops for

- precise cutting guide
- optimum yield
- high degree of operator safety

Horizontal cutting guide

	12.3 kg	160 mm	15 - 55 mm	IP 65	Electric, 3-phase	950 watts (50-60Hz)	1.3 hp (50-60Hz)
	27 lbs	6 1/2 inch	1/2 - 2 inch				

Thin saw blade 0.8 mm for

- clean cuts and surfaces
- low germ counts
- less sawdust
- optimum yield

BCK23-03

Circular bacon saw



Circular breaking saw with horizontal saw blade for medium & high throughput plants

For coarse cutting, cutting out the backbone of bacon half-carcasses of pigs

- Circular saw blade, coarse tooth, rust-free KGZ
- Spiral cable SK
- Round handle R (D type)
- Saw blade stop within 3 seconds after switch-off (EU standard)
- Mechanical motor brake MMB

	13 kg	230 mm	75 mm	IP 65	Electric, 3-phase	1300 watts (50-60Hz)	1.8 hp (50-60Hz)
	29 lbs	9 inch	3 inch				

SRC34-H5_evo2

Spare ribs cutter



For optimum separation of the ribs
(loin or back ribs) of split backbone

- Up to 2000 items/hour with trained personnel
- Clean, smooth and even cut
- Optimum extraction of the meat thanks to an additional extraction plate
- Consistent yield (practically no meat loss)
- Longer shelf life of the product thanks to better hygiene (hardly any sawdust)
- Safe working
- Laterally integrated conveyor belt for the ribs
- Low space requirement
- Transport rollers for a quick change of location



250 kg

551 lbs

345 mm

13 1/2 inch

IP 65

Electric,
3-phase

2800 watts
(50Hz)

3.0 hp
(50Hz)

- High degree of stability for the guides thanks to being locked via the tension lever
- Quick payback time due to the attractive price/performance ratio
- Circular knife blade can be re-sharpened
- Quick and easy to clean

RTC34

Rib Top Cutter



- High performance with up to 1500 cutlet strands per hour
- Circular knife blade technology
- Automatic cutting guide and ejection as well as outward conveyance of the portions
- Consistent precise cuts, less bone removal
- Less bone dust
- Good level of adjustability, including quick adjustment of the cutting depth
- Easy maintenance and cleaning
- Proven SRC drive technology
- Highly robust design
- Increased operator safety



260 kg
573 lbs



345 mm
13 1/2 inch



IP 65



Electric,
3-phase



2800 watts
(50Hz)
3.0 hp
(50Hz)



TRIMMING

TRIMMING

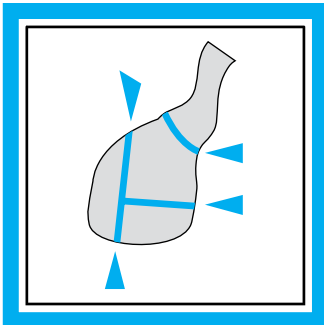

In modern meat processing, the type, efficiency and quality of the tools used have a significant influence on the quality of the end product and on the achievable yields.

It is not uncommon for high demands to be placed on such tools. This can result in maintenance-related downtimes and considerable servicing costs.

For this reason, developers of modern trimmers have the task of creating a product that is not only powerful and economical, but also low-wear and therefore cost-efficient. This is exactly the approach that we take here at FREUND.

With our latest Series 2 trimmers and the newly developed Trimmer_evo3, we have created products which - thanks to the use of proven components and high-quality materials - are a low-maintenance and therefore cost-saving alternative to the trimmers widely available on the market.

CONTENTS

	Trimming	73 - 98
	▶ Trimmer_evo3 Trimmer Motor_evo3	74 - 75
	▶ Trimmer_evo3 - Features/ Ring blade selection	76 - 81
	▶ Trimmer / Trimmer Motor	82-83
	▶ Trimmer - Features/ Ring blade selection	84 - 95
	▶ Sharpening	96 - 97
	▶ Derinding	98
	Optional accessories	100 - 106

TRIMMER_evo3

New quality Trimmer_evo3



35-128 mm



Videos on maintenance & care

- Better cutting performance for all applications
- Modular Design
- Integrated thumb rest
- Closed blade guide, easy assembly for the user
- Suitable for right- and left-handed people
- Improved power transmission of the drive to the blade
- Improved ergonomics thanks to perfectly balanced handpiece
- Weight reduction reduces hand fatigue
- Patented one-hand switch with the latest start-stop system with ergonomically integrated safety lever
- A puller for 6 different blades reduces costs and errors
- Patented one-hand switch with the latest start-stop system with ergonomically integrated safety lever
- Quality knives made from corrosion-resistant heavy-duty steel for many trimming/protein applications
- New multifunctional grease ring, optionally:
 - ▶ with grease nipple
 - ▶ with hand strap holder
 - ▶ with fat dispenser
- The "fat-free variant" reduces the number of foreign bodies
- Improved powertrain offers:
 - ▶ stress-free coupling of the motor and handpiece
 - ▶ higher flexibility & service life
 - ▶ fewer failures
- Low maintenance costs thanks to low-wear quality components
- ▶ Parts diagram can be accessed via FREUND Assistance (FA)
- ▶ **NOTE:**
Sharpening of suitable blades only with the TSM-E1 trimmer sharpener



TRIMMER 52_evo3

Trimmer 52_evo3 - variant with vacuum suction



- Ergonomic handle
- Flexible suction and delivery hose
- Ring blade types 52A or 52B for almost every application
- One-hand control with the latest start-stop system
- Suitable for right- and left-handed people

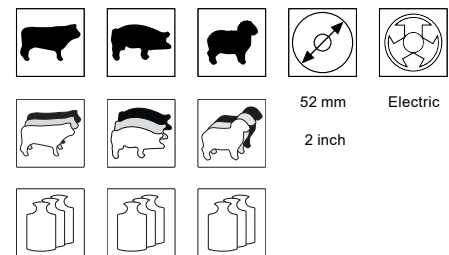

52 mm
2 inch
Electric

TM-E6000_evo3

Electric motor



- With up to 6000 rpm, all trimming operations are easier
- "Soft start" and "quick stop" of the rotating blade in conjunction with the rest position of the stainless steel handpiece holder for the highest safety standard
- 2-hand operation, maximum operator control/safety
- Engaging and disengaging the drive train, faster, easier and according to the highest safety standards
- extremely robust and waterproof thanks to the completely closed aluminum housing
- The hygienic design allows for easy cleaning and problem-free use in wet/damp environments (e.g. in slaughterhouses, on deep-sea fishing frigates, etc.)

► **NOTE:**
Motor can only be used in conjunction with Trimmer_evo3

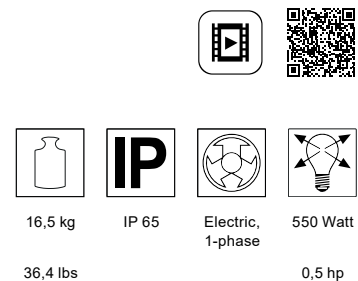

16,5 kg
36,4 lbs
IP 65
Electric, 1-phase
550 Watt
0,5 hp

- EU standard technology - stable supply chains reduce the risk of delivery bottlenecks
- Available in 2 versions: 230V or 115V

FEEL THE NEW POWER IN PERFECTION

Our new Trimmer_evo3 are a cost-saving alternative, designed with durable, robust components to provide excellent performance with low maintenance costs.

We present a variable modular system with quality components that offers advantages such as higher productivity, higher yields, more profits and improved

safety. The new system minimizes the need for spare parts and maintenance and service are more customer-friendly.

Thanks to the new ergonomic shape of the new series, comfortable, fatigue-free and more efficient work is guaranteed.

CARACTÉRISTIQUES DE LA TRIMMER_evo3

Modular construction Trimmer_evo3

Depth control

- uniform cutting depth (individually adjustable)
- higher yield due to reduced rejects
- in 2 stainless steel versions DCF(FET) / DCS(SKIN)

Multifunctional grease ring

- Various versions, including with/without grease nipples, with hand strap holder or with grease bushing (also suitable as a hand strap holder)

Thumb support

- Ergonomically designed for fatigue-free work
- Infinitely adjustable for right- and left-handed users
- significant increase in user safety

One-hand switch

- Low-vibration one-handed operation with start-stop safety system
- Separate grip and functional areas
- perfectly balanced by mass in the rear area
- Stop to counteract the force of pulling movements
- Binding the hand strap and vacuum hose holder

Trimmer handle

- hygienic and abrasion-resistant
- 2 versions (cylindrical/ergonomic) in 2 sizes (S/M)

Drive line

- High flexibility & lightweight
- Longer service life thanks to reinforced inner core (special fiber fabric) and vibration reduction



STANDARD VERSION

Ø (mm)	35	52	69	90	128
One hand switch cp	•	•	•	•	•
Frame	small	small	small	large	large
Bearing (plastic)	•	•	•	•	•
Pinion	small	small	small	large	large
Steeling device				•	•
Quick release	•	•	•	•	•
Handle ergonomic EM (middle)	•	•	•	•	•
Blade	A (straight)	A (straight)	A (straight)	C 45°	C 45°

OPTIONAL

Blade SCR16	•				
Blade SCR19	•				
Blade A (straight)	•	•	•	•	
Blade B (hook)	•	•		•	
Blade C (flat/short/serrated)			C / C serrated	C 30°	C 30°
Blade D (flat/short)					•
Depth control				DCF/DCS	DCF/DCS
Hose adapter and hose bracket for vacuum hose	•	•			
Bearing (bronze)	•	•	•	•	•
Grease ring w/o grease bush	•	•	•	•	•
Thumb support (plastic)	•	•	•	•	•
Handle ergonomic ES (small)	•	•	•	•	•
Handle cylindric M (middle)	•	•	•	•	•
S (small)	•	•	•	•	•
Strap	•	•	•	•	•



*The Image shows some of the possible configurations

TRIMMER_evo3

Exploded view of one of the possible variants for TRIMMER E90_evo3

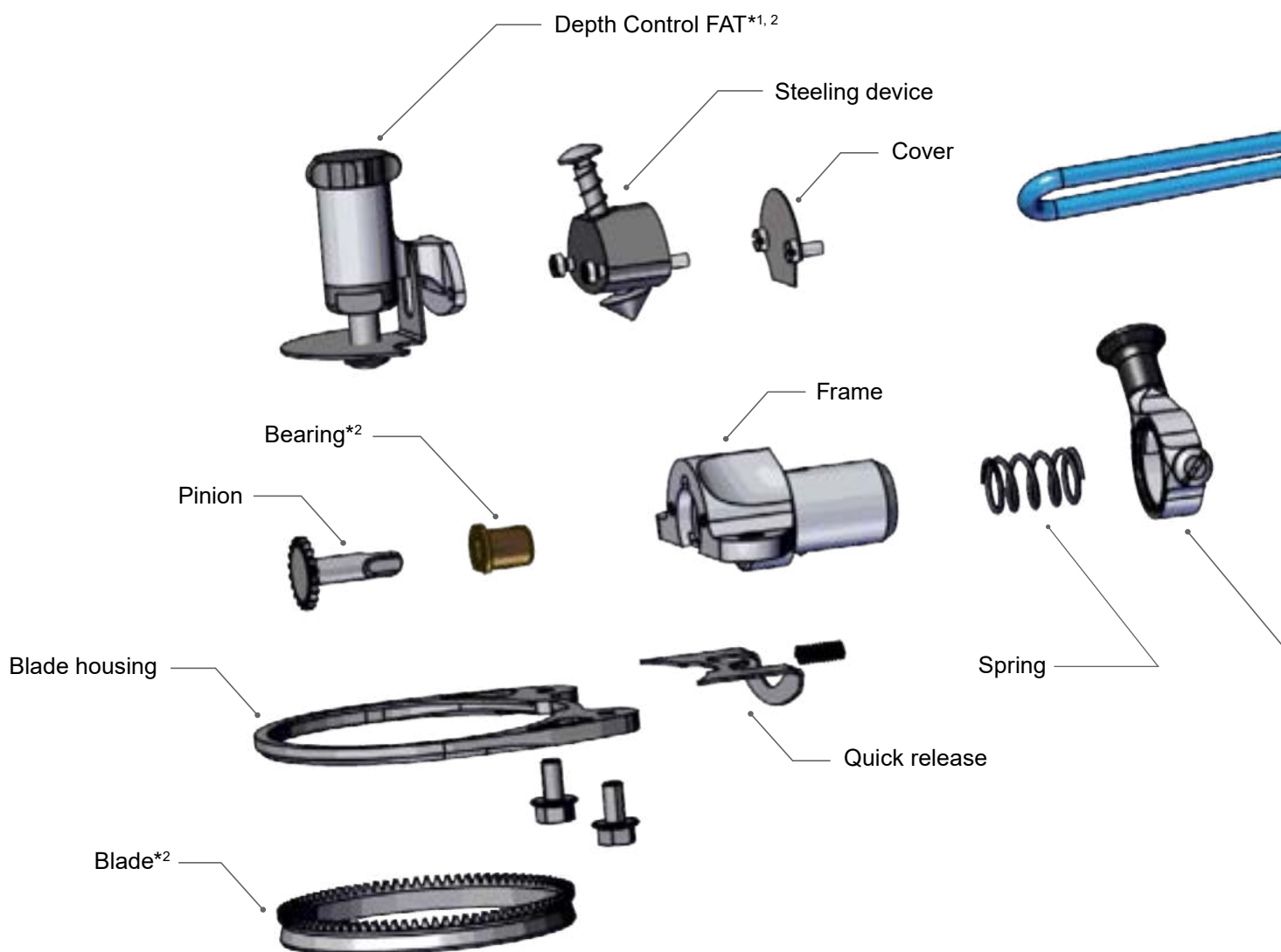

*¹ optional / *² available in various versions



Exploded views of
Trimmer_evo3 / electric

TRIMMER

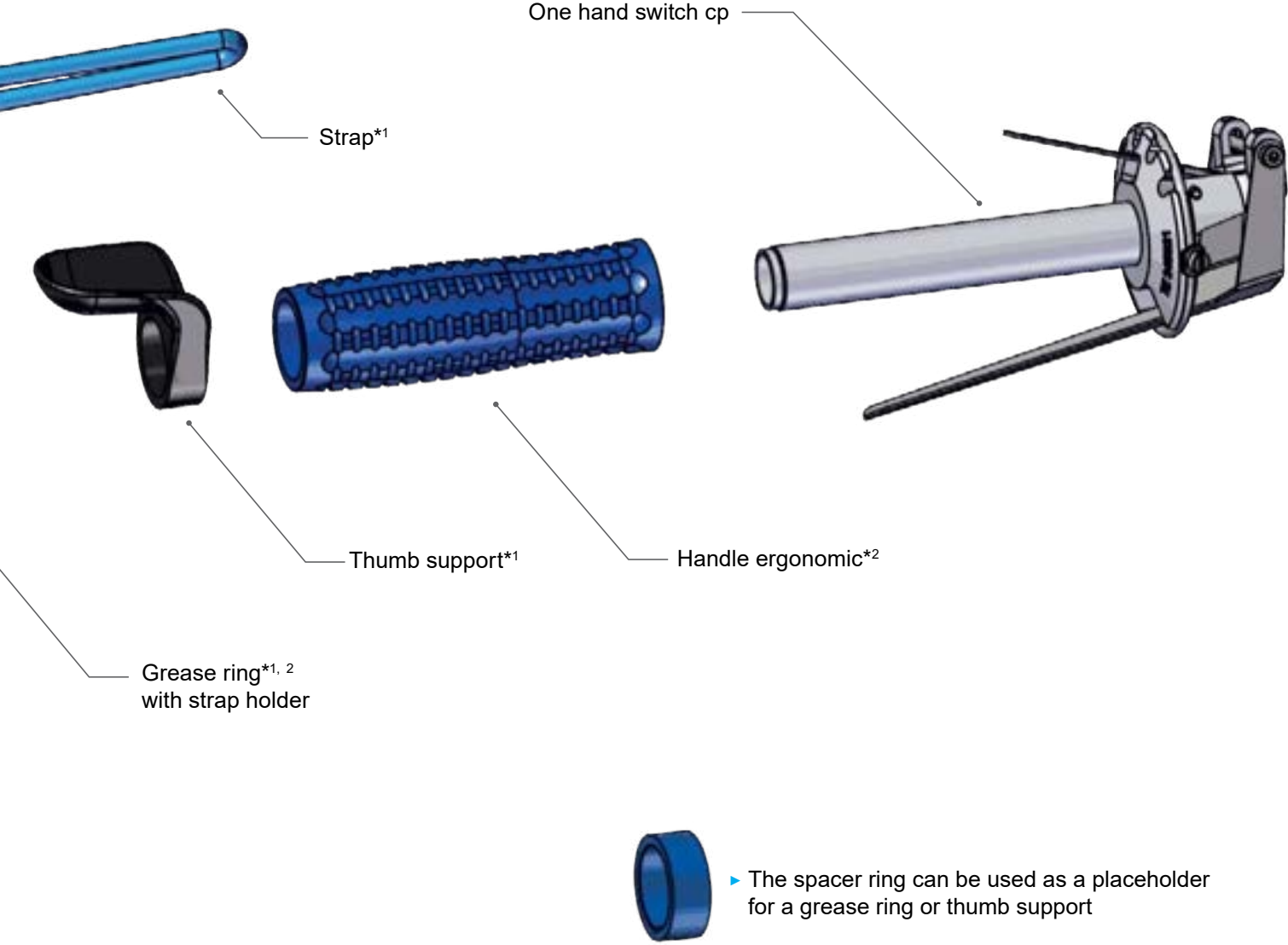

*Figure shows one of the configuration options

TRIMMER_evo3

Ring blade selection



RING BLADE SELECTION

Type	Ø (mm)	35	52	69	90	128
A (straight)		•	•	•	•	
B (hook)		•	•		•	
C (short/flat/serrated)				•	•	•
D (long flat)						•

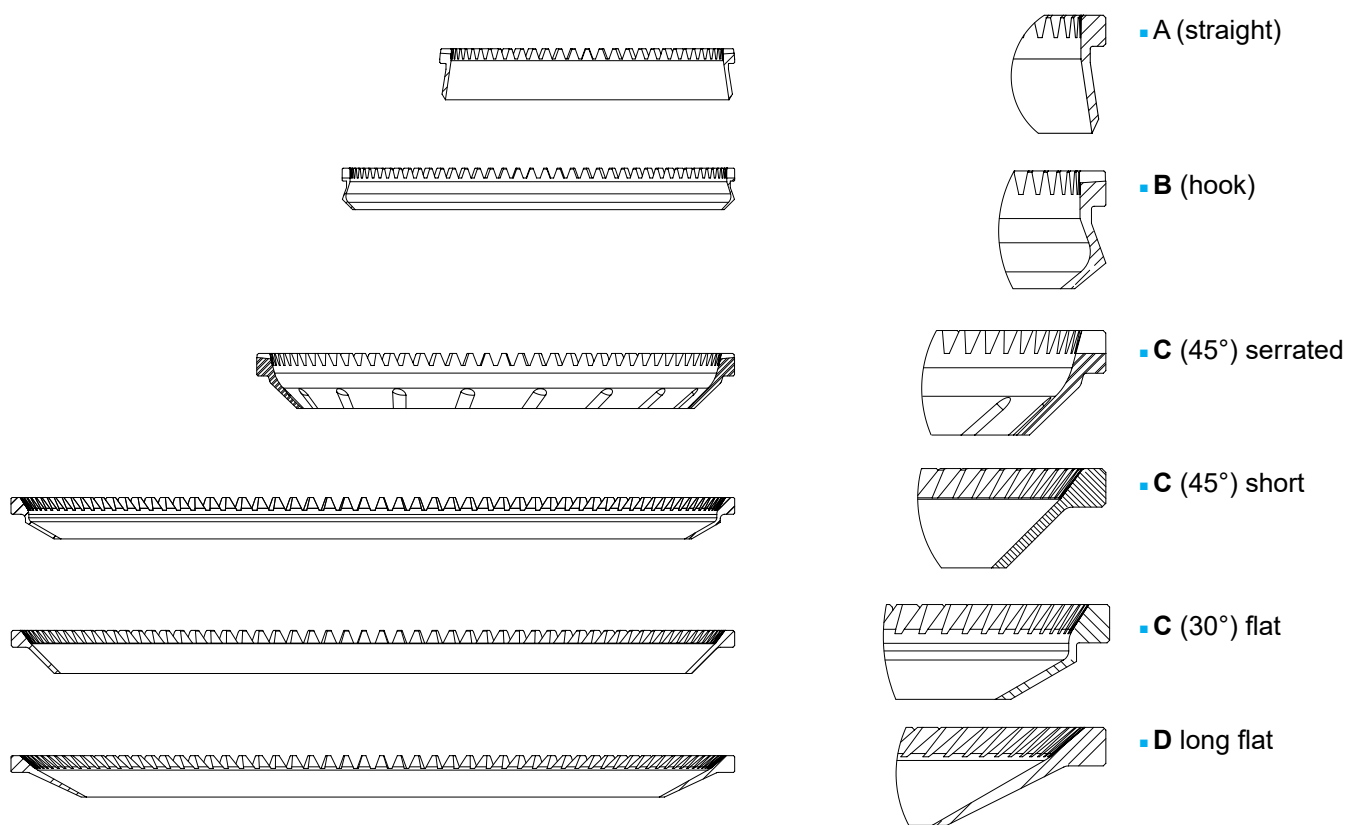

TRIMMER_evo3

Ring blade application



APPLICATION

	Ø (mm)	35	52	69	90	128
Deboning / cleaning						
Bones		A	A			
Heads		A	A	A / C	A	
Chicken thighs		A	A			
Ribs from belly		A				
Removal						
Cheeks				A / C	A	
Chicken breast			B		B	
Spinal cord			A / B			
Remaining skin				C	C	C
Veins and glands	A	A				
Pig eyes	A					
Pork fillet				A	A	
Lean meat from fat				C		C
Tuna					C	C
Degreasing / trimming						
Skins					C	C
Warm fat trimming					C	C
Hard fat trimming					B	D
Ham / shoulder / cutlet				C	B / C	C
Slicing						
Salmon	B			A / C		C
Gyros / doner kebab					C	C



TRIMMER

Quality trimmer



- Optionally powered electrically or pneumatically
- Further enhanced trimmer blade surface
- Less downtime and lower servicing costs thanks to low-wear quality components
- Ergonomic handle with robust and abrasion-free plastic design
- Patented quick-change blade system for toolless trimmer blade change
- Significant improvement of user safety thanks to optional start-stop safety system
- Quiet operation minimises vibrations on the handle
- Four different measurement types A, B, C and D in diameters Ø 35, 52, 69, 90 and 128 mm
- Optionally available with depth control in different user-oriented designs



35-128 mm



Videos on maintenance & care

PNM2

Pneumatic-motor



PNM2-D34

*Figure also shows trimmer Ø 35 mm



- Handle with integrated pneumatic-motor for compressed air operation with 6 bar
- new PNM2-D34 handle with 34mm diameter for better handling
- Can be used with FREUND Trimmers (except Trimmer_evo3)
- Start-stop safety system with stop lever
- Non-slip handle
- Available with pneumatic connecting kit including service unit and couplings (recommended)

0.6 kg 6 bar Pneumatic 250 watts
1.3 lbs 87 psi

TRIMMER 52

Trimmer - variant with vacuum suction

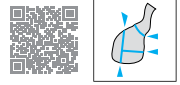

- Application-optimised design
- Easy handling thanks to spherical suction head
- Various blade types (straight ring blade, hook ring blade)
- Minimal downtime and servicing costs thanks to low-wear quality components
- Ergonomic handle with robust and abrasion-free plastic design
- Quiet operation minimises vibrations on the handle
- Optionally powered electrically or pneumatically

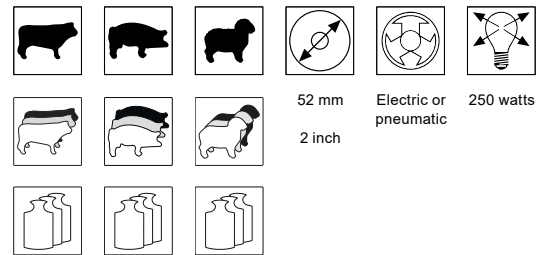

TM-E6001 EF2_evo2

Electric motor



- Integrated handles suspension
- adjustable to 6500rpm
- Less downtime thanks to low-wear operation
- Compact and lightweight aluminium housing
- Hygienic design
- Handles and trimmers (except Trimmer_evo3) can be used individually

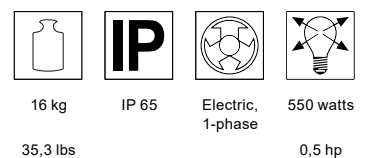

TM-E6001 EF2_evo2
230V - 100Hz - 4500 U/min

Connection unit EF2

- Enables conversion from EF1 to EF2 (Part-No. 028-010-015)



From defatting degreasing of meat, poultry and fish products to precision cutting of wafer-thin salmon slices – with our optionally electrically or pneumatically powered trimmers, we offer you the right tool for the diverse requirements of your plant.

At the same time, the modular design of our trimmers gives you the option of choosing from four different blade types in five diameters (35, 52, 69, 90 and 128 mm) and countless optional features such as an ergonomic thumb rest, depth control in a robust and hygienic stainless steel design and many other features.

TRIMMER FEATURES

The right machine for every application

Trimmer modules

Depth control

- Even cutting depth (individually adjustable)
- Higher yield thanks to lower number of rejects
- Especially suited to cutting & filleting salmon and kebab in variant DCS (plastic) and DC2S (stainless steel)
- Especially suited for degreasing hard and cold meat in variants DCF (plastic) and DC2F (stainless steel)

Thumb rest

- Ergonomically shaped to enable fatigue-free working
- Freely adjustable for right- and left-handers
- Significant increase in user safety

Trimmer handpieces

- Ergonomically shaped, abrasion-free and hygienic
- Optimal handling thanks to different handle shapes
- Available in handle diameters 31, 34 and 38 mm

Connecting kits EF1 / EF2 / ADAPTIVE

- Low-maintenance thanks to integrated coupling sleeve
- Compatible with all FREUND hand pieces
- Also available as a special ADAPTIVE version to enable further use of your existing trimmer motor¹

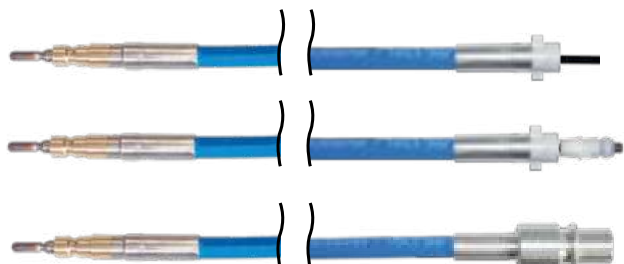

¹) compatible with common trimmer motors

OPTIONS

	Ø (mm)	35	52	69	90	128
A (straight)		•	•	•	•	
B (hook)		•	•		•	
C (short flat)					•	•
D (long flat)						•
Depth control					DCF / DCS	DCS /DC2F / DC2S
Pinion gear and Bushing		Small	small	small	large	large
Thumb rest		•	•	•	•	•
Grease cup		Small/large	small/large	small/large	small/large	small/large
Steeling device only					•	•
Pneumatic-motor PNM2		•	•	•	•	•
Start-stop safety system		•	•	•	•	•
Grease fitting and vacuum suction system		•	•			



TRIMMER

Bearing plastic design



- all saleable trimmer handpieces can be equipped with the newly configurable plastic plain bearing
- available without an extra charge
- high endurance
- additional lubrication of the pinion is not necessary
- the daily greasing of the plain bearing is no longer necessary
- minimal weight reduction of the handpiece
- the handpiece is supplied without grease nipple and grease bushing (a blind plug is fitted)

Extractor

Blade guide

Pinion

Bearing

Bearing plastic design

Cutting depth control

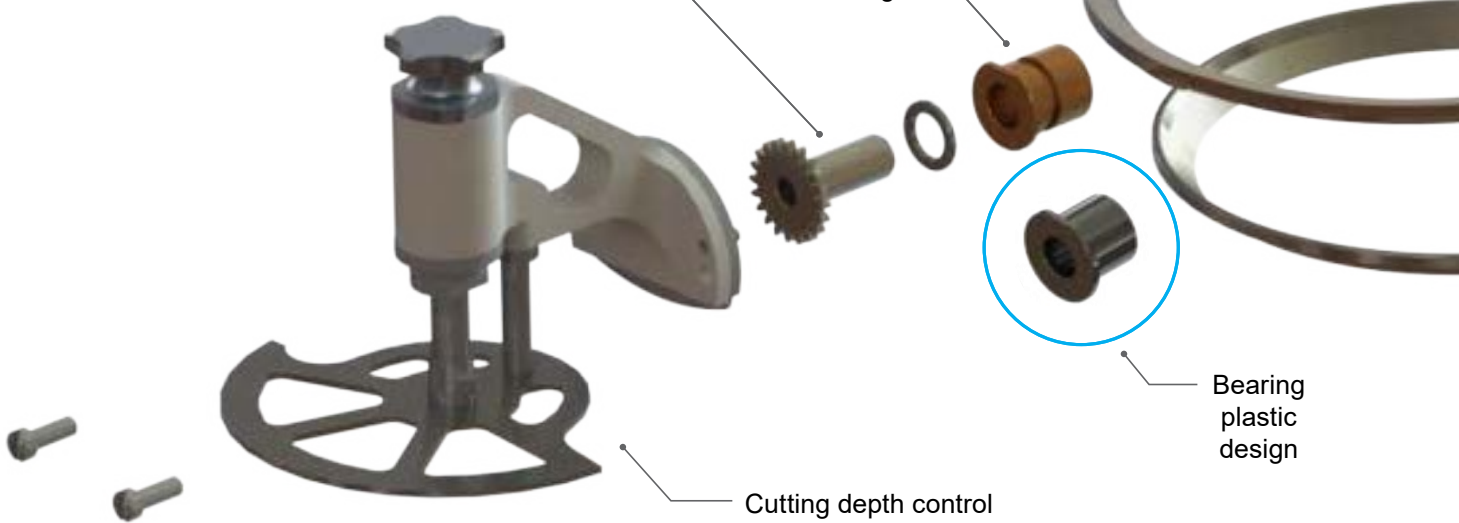

Exploded view TRIMMER ø 35mm variant with vacuum extraction, elektrisch und pneumatisch

TRIMMER

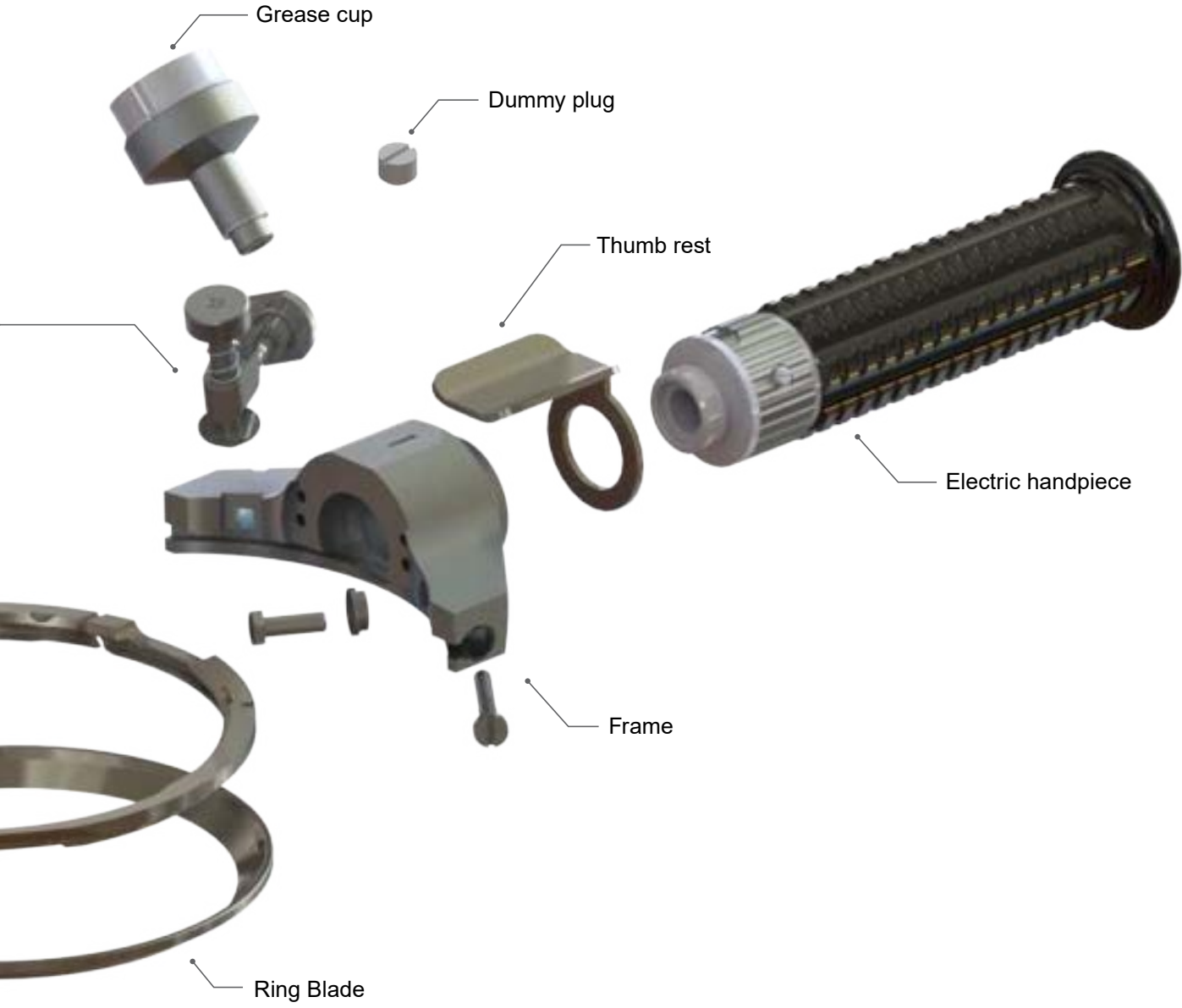

Exploded view
TRIMMER ø 90mm
pneumatic

*Figure shows one of the configuration options of electric TRIMMER ø128mm

TRIMMER

Ring blade selection



RING BLADE SELECTION

Type	Ø (mm)	35	52	69	90	128
A (straight)		•	•	•	•	
B (hook)		•	•		•	
C (short flat)					•	•
D (long flat)						•

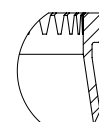
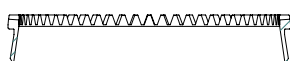

■ A (straight)

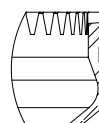
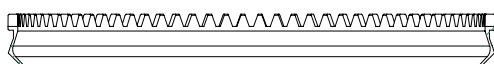

■ B (hook)

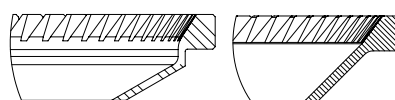
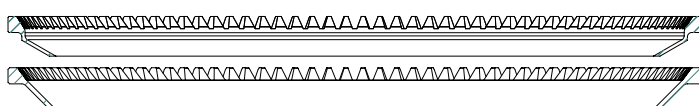

■ C (short flat)
30° / 45°

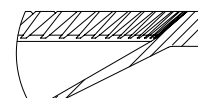
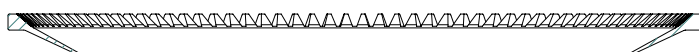

■ D (long flat)



TRIMMER

Ring blade application



APPLICATION

	Ø (mm)	35	52	69	90	128
Deboning / cleaning						
Bones		A	A			
Heads		A	A	A	A	
Chicken thighs		A	A			
Ribs from belly		A				
Removal						
Cheeks				A	A	
Chicken breast			B		B	
Spinal cord			A / B			
Remaining skin					C	C
Veins and glands		A	A			
Pig eyes		A				
Pork fillet				A	A	
Lean meat from fat						C
Tuna					C	C
Degreasing / trimming						
Skins					C	C
Warm fat trimming					C	C
Hard fat trimming					B	D
Ham / shoulder / cutlet					B / C	C
Slicing						
Salmon				A		C
Gyros / doner kebab					C	C



TRIMMER IN THE FISH INDUSTRY

TRIMMING





TRIMS FROM A-F

EFFECTIVE

CONTROLLED

MAXIMUM YIELD

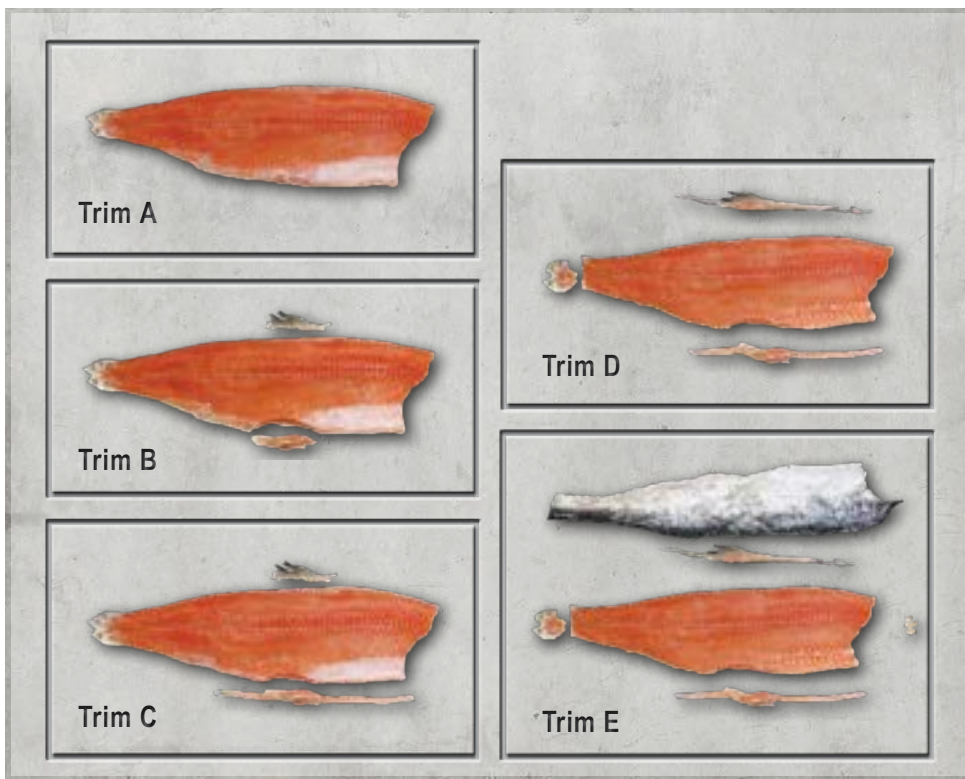
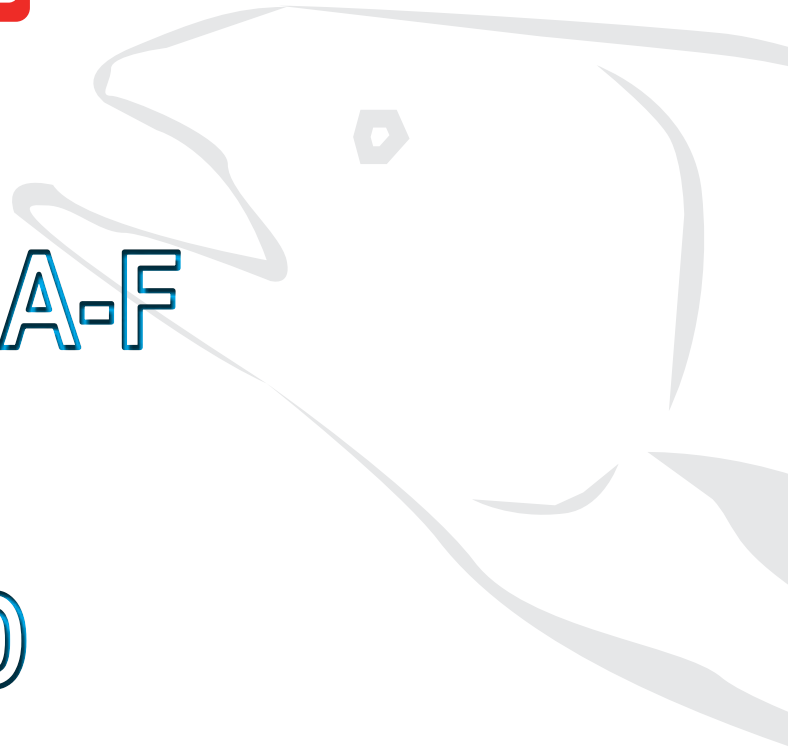

SUITABLE FOR ALL TYPES OF TRIM!

With our trimmers you can perform any trim with high yields on the fillet.

With a choice of electrically or pneumatically operated trimmers, we offer you the right hand tool for the diverse requirements on your farm.

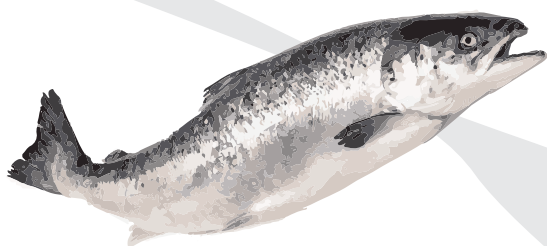

**CLEAN & TIDY CUT
DUE TO DEPTH CONTROL**



MORE PROFIT THROUGH HIGHER YIELD!

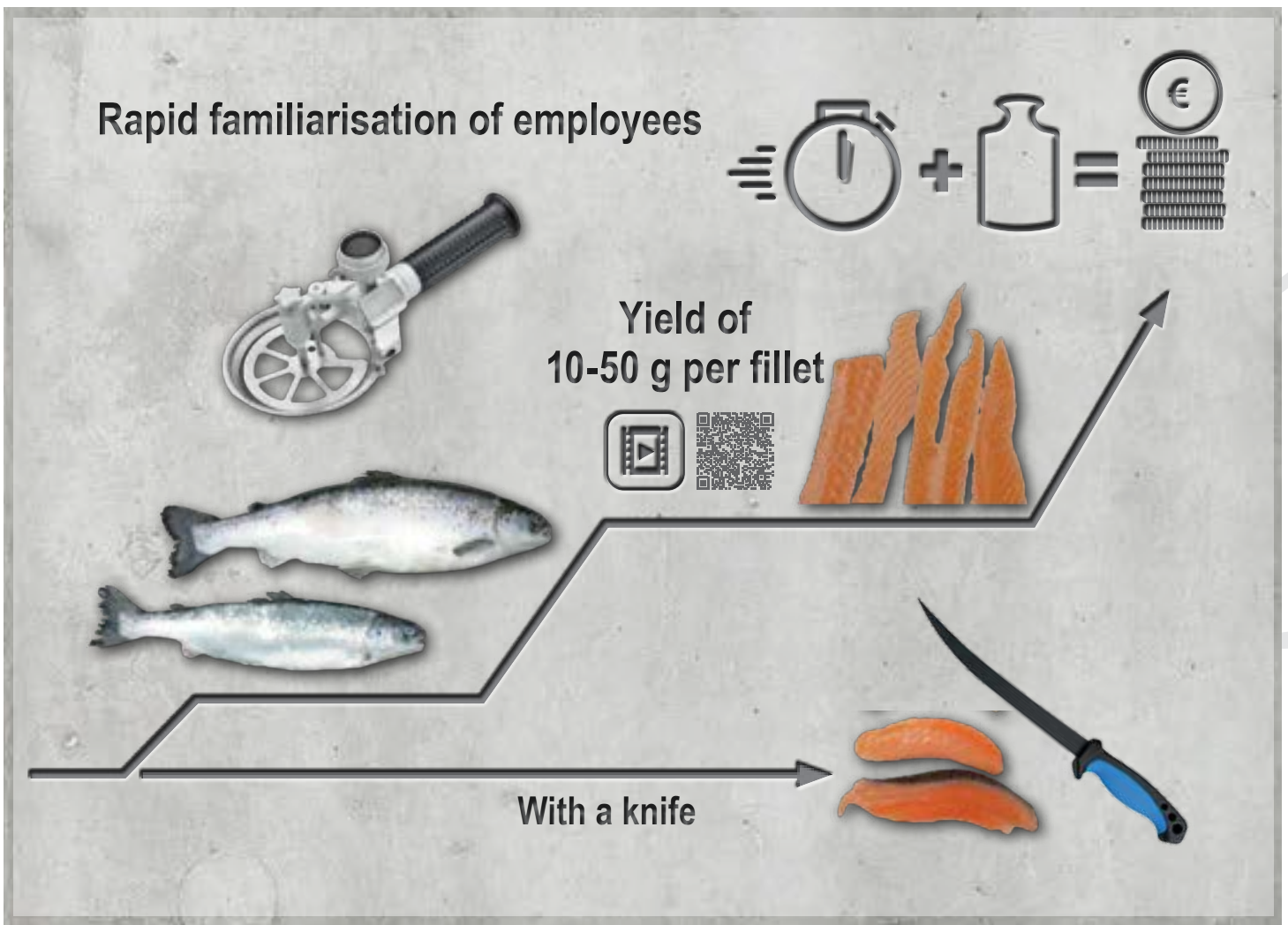

TRIMMING

TRIMMER ELECTRIC OR PNEUMATIC

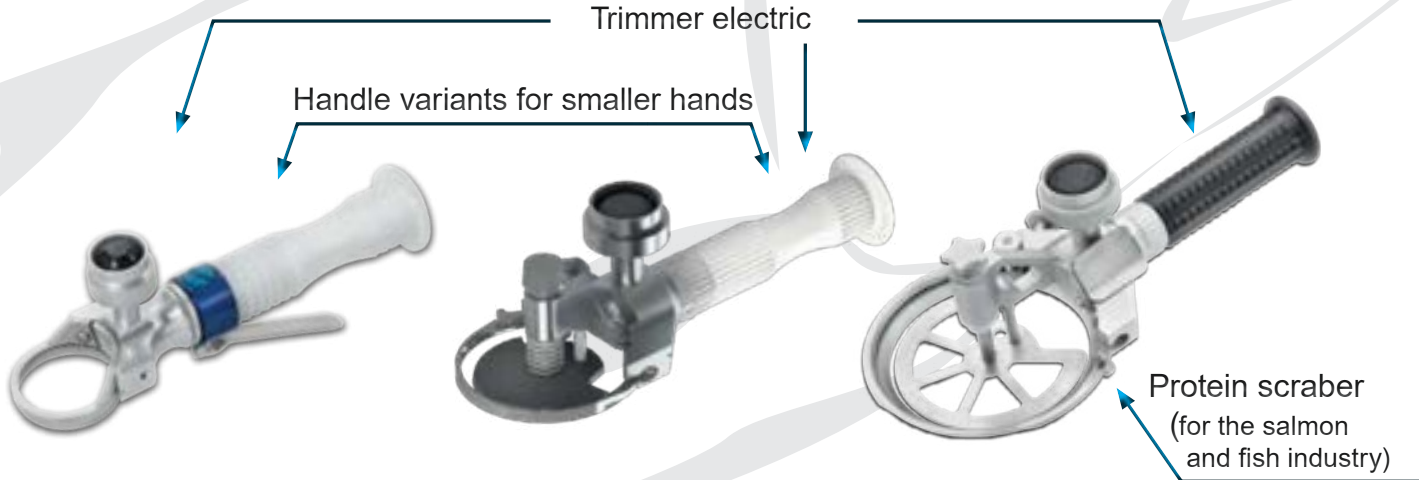

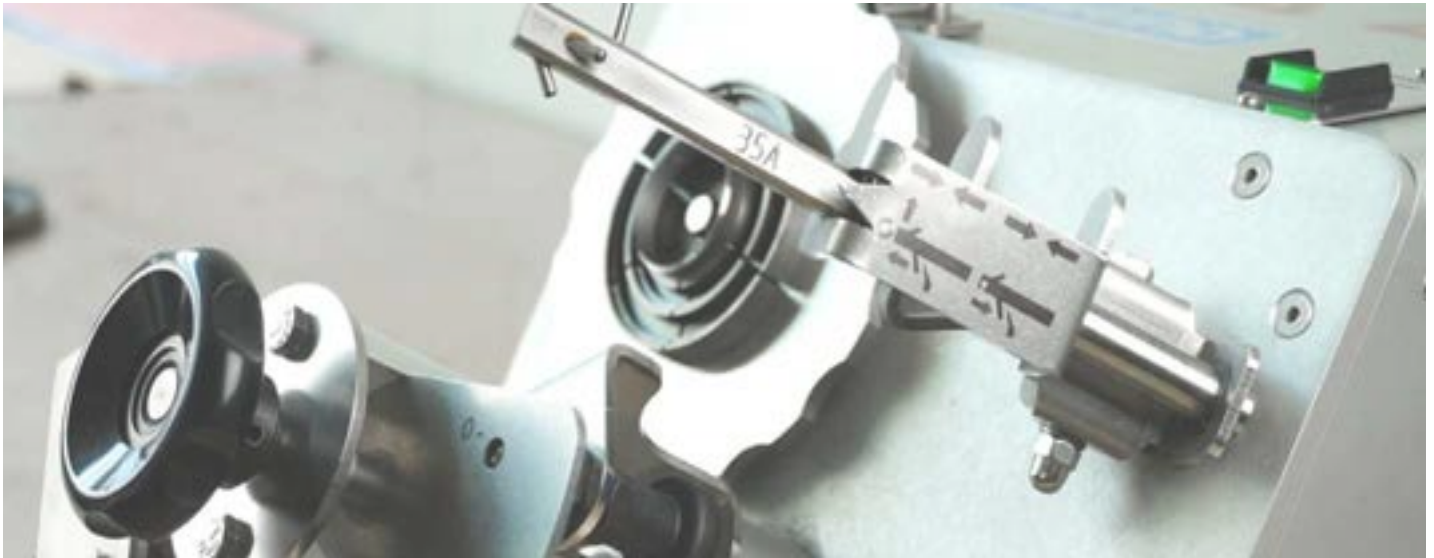

TSM-E1

Trimmer sharpening machine



*Figure: Standard variant with steeling device for blades Ø 69 -128mm

Trimmer sharpening machine for optimum sharpening results

- Precise sharpening of suitable trimmer blades for all FREUND trimmers in all diameters
- Quick clamp device in two different sizes enables rapid insertion of the trimmer blade with minimal installation effort
- Spring-loaded deburring lever prevents contact being too forceful
- Pre-coated precision grinding disc enables optimum sharpening results while, at the same time, ensuring the maximum service life for the grinding unit
- Integrated overload display indicates potential overload
- Compact aluminium housing with stable design
- Drive with up to 8000 rpm

OPTIONAL: ▶ Steeling device for Ø 35 and 52 mm available



13.8 kg
30 lbs



IP 32



Electric,
1-phase



150 watts
(50 Hz)

SCHÄRFSTAHL

Sharpening steel



- Precision resharpening of trimmer blades of type A 35 / 52 / 69 mm and trimmer blades of type B,C and D 90 / 128 mm
- Significant improvement of surface thanks to fine removal of material from the blade
- Increased service life for trimmer blades thanks to improved surface
- Design made of resistant chrome/vanadium alloy tool steel



344 g

0.8 lbs



248 mm

9.8 inch



12.9 mm

0.5 inch

SCHÄRFSTAHL-HAKEN

Sharpening steel hook



- Precision resharpening of trimmer blades of type A 35 / 52 / 69 mm and trimmer blades of type B,C and D 90 / 128 mm
- Significant improvement of surface thanks to fine removal of material from the blade
- Increased service life for trimmer blades thanks to improved surface
- Design made of resistant chrome/vanadium alloy tool steel



92 g

0.2 lbs



190 mm

7.5 inch



6.5 mm

0.25 inch

SCHÄRFSTAHL FÜR ARBEITSTISCHE

Sharpening steel for work tables



- Precision resharpening of trimmer blades of type B, C and D 90 / 128 mm
- Significant improvement of surface thanks to fine removal of material from the blade
- Increased service life for trimmer blades thanks to improved surface
- special design enables clamping in screwing device and attachment to work table
- Design made of hardened chrome/vanadium alloy cold work steel



270 g

0.6 lbs



160 mm

6.3 inch



9.5 mm

0.37 inch

HSK8-P5

Hand-Skinner (pneumatic)



- Quick coupling system with bayonet lock
- Exhaust air outside the working area
- The quietest machine in use on the market



		1,8 kg	76 mm	3,5 mm	6 bar	Pneumatic	660 watts
		4 lbs	3 inch	0,14 inch	87 psi		0,89 hp



Hand-Skinner for easy skinning of pork halves and pig sections (cold fat trimming)

- Blade quick-change system for tool-less blade change
- High degree of operational safety

Powerful pneumatic-motor "Made in Germany"

Maintenance-friendly:

- Easy disassembly
- All parts of the roller are individually replaceable

- Easy cleaning thanks to the hygienic design
- No dead spaces where dirt can accumulate
- Stable design
- With stainless steel safety guard
- Stainless steel scraper
- Low-noise operation
- Suitable for right- and left-handers



Videos on maintenance & care

HSK8-P3_evo2

Hand-Skinner (pneumatic)



- Direct compressed air connection to the motor

		1,6 kg	76 mm	3,5 mm	6 bar	Pneumatic	320 watts
		3,5 lbs	3 inch	0,14 inch	87 psi		0,43 hp

TECHNICAL SUPPORT

OPTIMUM PLANNING

Excellent service is an important factor for customer loyalty – all of us at FREUND embody this belief. Whether it's maintenance, complaints or repairs – efficient service processes not only ensure satisfied customers, but also set us apart from the competition thanks to the comprehensive and meticulous technical service we offer.

PROFESSIONAL SERVICE

The basis for optimum service is the precise planning and handling of all our service offers. Based on a history of your existing machines, our team members are highly knowledgeable when it comes to your FREUND machines. In compliance with statutory requirements, you will receive a test certificate after any repair work.

ARRANGING AN APPOINTMENT

When a service request is received, our service team members immediately see which equipment is available and when. In order to keep your production downtime to a minimum, we offer you rental equipment of equal value during the repair period. Service lives are lengthened and downtimes are minimised, which has a positive impact on the life of FREUND machines and ensures a faultless production process. Our collection service will also save you time and effort and guarantees secure packaging for the transport process.

SERVICING

Special tools and decades of industry experience allow for flawless repair work in accordance with technical requirements. Only original parts and auxiliary materials are used - all of which have been approved via our in-house quality control. Thanks to the updates that are directly accounted for in the repair process, your product always complies with the latest technological standards.

Lower your operating costs via regular maintenance and repairs.

DIVERSE SERVICE PORTFOLIO

Multiple tasks can be entered for a service order. Such tasks are assigned to our service team. Our qualified employees provide professional advice and support, which is carried out in a skilful manner, on time and carefully according to our company philosophy.

You can reach our technical service via the following channels.:

Phone: +49 5251 1659-46

E-Mail: service@freund.eu



OPTIONAL ACCESSORIES

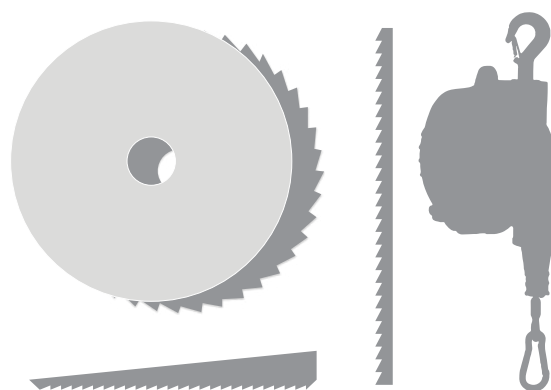





CONTENTS

Optional accessories	100 - 106
Circular saw blades	101
Breaking saw blades/ reciprocating saw blades/ band saw blades	102 - 103
Circular knife blades	103
Spring balancers	104 - 105
Disinfection cabinets/ disinfection pools	106

OPTIONAL

Circular saw blades (optional accessories)



TYPE	∅ mm	APPLICATION			Q	 	TYPE	PART NO.
								
Fine tooth	160	•	•	•	120	1.1	KFZ160	220-000-011
Fine tooth		•	•	•	120	0.8	KFZ160	220-000-012
Coarse tooth	180	•	•	•	60	0.8	KGZ160	220-005-014
Fine tooth		•	•	•	120	1.3	KFZ180	220-000-004
Coarse tooth	230	•	•	•	90	1.3	KGZ180	220-005-003
Special tooth		•	•	•	14	1.3	KSZ180	220-010-004
Special tooth, low-noise	280	•	•	•	120*	1.2	KSZ180GA	220-000-506
Hard metal circular saw blade		•	•	•	30	1.4	KHZ180GH	220-100-001
Fine tooth	320	•	•	•	150	1.5	KFZ230	220-000-005
Coarse tooth		•	•	•	110	1.5	KGZ230	220-005-000
Coarse tooth, low-noise	400	•	•	•	60	1.5	KGZ230-60GA	220-005-550
Special tooth		•	•	•	18	1.3	KSZ230-16	220-010-050
Special tooth, low-noise	520	•	•	•	120*	1.7	KSZ230GA	220-000-507
Hard metal circular saw blade		•	•	•	36	1.7	KHZ230GA	220-100-003
Fine tooth	for	•	•	•	200	1.5	KFZ280	200-000-006
Coarse tooth		•	•	•	140	1.6	KGZ280	220-005-005
Special tooth for horns and legs	HBK33-08	•	•	•	18	2.2	KSZ280H	220-010-006
Special tooth, low-noise		•	•	•	144*	1.7	KSZ280GA	220-000-508
Hard metal circular saw blade	FK40-08	•	•	•	40	1.7	KHZ280GA	220-100-005
Coarse tooth		•	•	•	160	1.6	KGZ320	220-005-006
Special tooth, low-noise	for	•	•	•	144*	1.7	KSZ320GA	220-000-509
Hard metal circular saw blade		•	•	•	40	1.7	KHZ320GA	220-100-006
Special tooth for horns and legs	HBK33-08	•	•	•	28	2.2	KSZ320H	220-010-008
Hard metal coarse tooth for horns		•	•	•	40	2.2	KHZ320HGA	220-100-010
Coarse tooth for splitting	400	•	•	•	100	1.2	KGZ400SPGA	220-006-001
Special tooth for splitting		•	•	•	180*	1.7	KSZ400SPGA	220-000-512
Hard metal coarse tooth for splitting	FK40-08	•	•	•	52	1.6	KHZ400SPGA	220-100-013
Hard metal coarse tooth		•	•	•	52	2.2	KHZ400GA-FK	220-100-014
Special tooth, low-noise	520	•	•	•	64	1.2	KSZ400-64GA	220-000-515
Coarse tooth for splitting		•	•	•	130	1.2	KGZ520SPGA	220-006-002
Special tooth for splitting	for	•	•	•	272	1.3	KSZ520SPGA	220-000-513
Hard metal coarse tooth for splitting		•	•	•	60	1.6	KHZ520SP	220-100-012

*Number of cutting teeth without intermediate teeth



OPTIONAL

Breaking saw blades / reciprocating saw blades / band saw blades (optional accessories)



BREAKING SAW BLADES

TOOTHING	LENGTH [MM]	TYPE	PART NO.
Fine tooth	300	STFZ 300	222-000-002
Coarse tooth	300	STGZ 300	On request
Fine tooth for breastbone	315	STFZ 315 BB	222-000-510
Fine tooth	400	STFZ 400	222-000-003
Fine tooth	500	STFZ 500	222-000-011

RECIPROCATING SAW BLADES

TOOTHING	LENGTH [MM]	TYPE	PART NO.
Fine tooth for breastbone	300	HUFZ 300 BB	223-000-001
Coarse tooth for breastbone	300	HUGZ 300 BB	223-005-007
Fine tooth for splitting	600	HUFZ 600 SP	223-000-102
Coarse tooth for splitting	600	HUGZ 600 SP	223-005-102

BAND SAW BLADES FOR TABLE BAND SAWS

for FREUND model	TYPE	PART NO.
TBS19KT	BA6/1750X16	225-200-002
TBS23KT	BA6/2170X16	225-200-022
TBS28FT / ST	BA6/2430X16	225-212-004
TBS40FT / ST	BA6/315X16	225-200-001



OPTIONAL

Band saw blades / circular knife blades (optional accessories)



BAND SAW BLADES FOR SPLITTER BAND SAWS

- ▶ Packaging unit:
5 items per box
- ▶ Minimum purchase quantity:
20 items per size



for FREUND model	TYPE	PART NO.
SB 46-08	BA 46 FA	224-010-004
	BA 46 GA	224-011-004
	BA 46 GC	224-011-204
SB49-08	BA 49 FA	224-010-006
	BA 49 FC	224-010-206
	BA 49 GA	224-011-006
SB 50-08	BA 49 GC	224-011-206
	BA 50 FA	224-010-005
	BA 50 FC	224-010-205
	BA 50 GA	224-011-005
	BA 50 GC	224-011-205

QUALITY	PITCH	TOOTHING
FA	8 mm / 3 tpi	Standard 8 mm
FC	10 mm	Cleaning tooth
GA	8 mm / 3 tpi	Standard 8 mm
GC	10 mm	Cleaning tooth

For band saw blades for machines of other manufacturers, please contact our sales team by calling +49 5251 1659 -46



CIRCULAR KNIFE BLADES

For FREUND model	TYPE	PART NO.
BBKM / ZKM 25	KM250WHT-2F	230-250-006
SRC 34	KM345WD-1F	230-345-001
ZKM 60	KM600WHT-1F	230-600-009
	KM600WHT-2F	230-600-010
ZKM 75	KM750-WHT-1F	230-750-017
	KM750-WHT-2F	230-750-018
ZKM 95	KM950-WHT-1F	230-950-004



OPTIONAL

Spring balancers - special hygienic design for the food industry



SPRING BALANCERS WITH CABLE EXTENSIONS UP TO 2,0 M

TYPE		CABLE EXTENSION		BALANCING RANGE		WEIGHT, GROSS		PART NO.
		m	ft	kg	lbs	kg	lbs	
F14-2SK	S	2,0	6,5	10 - 14	22 - 31	7	16	920-426-100
F18-2SK	S	2,0	6,5	14 - 18	31 - 40	8	18	920-430-100
F22-2SK	S	2,0	6,5	18 - 22	40 - 49	8	18	920-431-100
F25-2SK	S	2,0	6,5	20 - 25	44 - 56	8	18	920-432-100
F30-2	S	2,0	6,5	25 - 30	56 - 67	12	26	920-436-000
F35-2	S	2,0	6,5	30 - 35	67 - 78	12	26	920-437-000
F45-2	S	2,0	6,5	35 - 45	78 - 100	13	28	920-438-000
F55-2SK	S	2,0	6,5	45 - 55	100 - 122	13	28	920-439-100
F65-2	S	2,0	6,5	55 - 65	122 - 143	14	30	920-440-000
F75-2		2,0	6,5	65 - 75	143 - 165	15	32	920-441-000

SPRING BALANCERS WITH CABLE EXTENSIONS UP TO 2,5 M

TYPE		CABLE EXTENSION		BALANCING RANGE		WEIGHT, GROSS		PART NO.
		m	ft	kg	lbs	kg	lbs	
F4-2,5	S	2,5	8	2-4	4-9	3	7	920-414-001
F6-2,5SK	S	2,5	8	4-6	9-13	4	9	920-415-102
F8-2,5SK	S	2,5	8	6-8	13-18	4	9	920-416-101
F10-2,5SK	S	2,5	8	8-10	18-22	4	9	920-417-101
F14-2,5SK	S	2,5	8	10-14	22-31	4	9	920-418-101

OPTIONAL



**SPRING BALANCERS WITH
CABLE EXTENSIONS UP TO 3,0 M**

TYPE		CABLE EXTENSION		BALANCING RANGE		WEIGHT, GROSS		PART NO.
		m	ft	kg	lbs	kg	lbs	
F20-3SK	S	3	10	15-20	33-44	19	42	920-470-100
F25-3		3	10	20-25	44-56	20	44	920-471-000
F35-3	S	3	10	25-35	56-78	21	46	920-472-000
F45-3	S	3	10	35-45	78-100	24	53	920-473-000
F50-3	S	3	10	40-50	89-111	24	53	920-474-000
F60-3	S	3	10	50-60	111-133	25	56	920-475-000
F70-3	S	3	10	60-70	133-156	27	60	920-476-000
F80-3		3	10	70-80	156-178	28	62	920-477-000
F90-3	S	3	10	80-90	178-200	29	64	920-478-000
F100-3	S	3	10	80-100	178-222	29	64	920-479-000
F115-3		3	10	100-115	222-253	40	88	920-480-000
F130-3		3	10	115-130	253-260	40	88	920-481-000
F140-3		3	10	130-140	260-308	43	95	920-482-000
F150-3		3	10	140-150	308-330	46	100	920-483-000
F160-3		3	10	150-160	330-352	49	108	920-484-000
F180-3		3	10	160-180	352-396	50	110	920-485-000



OPTIONAL

Disinfection cabinets / disinfection pools (optional accessories)



DISINFECTATION CABINETS

TYPE	FOR FREUND MACHINES		PART NO.
DES-K01	BBH30-03	BBST30-13	913-501-502
	FNS9P	HDS15	
	FNS9	K18-13	
	FS6		
DES-K02	BBK23-03	K23-03	913-506-003
	BBK28-06D	K23-03L	
	BBKM25-03	K23-06	
	HBK28-06	K28-03	
	HLS12	K28-03L	
	HZ7	K28-06	
	HZ10	K32-06	
	LS15		
	PFK23-03		
	SK28-03L		
DES-K03	SH60-03	SST50-13	913-503-502
	ST40-13		
DES-K04	SB46-08	SB49-08	913-505-002
	SB50-08		
DES-K05	LS15	NS21	913-509-00
	NS26	AS28	
DES-K06-ROD			913-508-002
DES-K07	HBK33-08	SK40-08L	913-510-000
	SK52-08L		
DES-K08	HG12		913-511-000

DISINFECTATION POOLS

TYPE	FOR FREUND MACHINES		PART NO.
DES-B01	VH38B	VH38I	913-101-220
	VH38E	SVH38A	
	VH38G	SVH38B	
	VH38H	SD11	



INDEX

Accessory set for cleaning captive bolt stunners	27	OPTIONAL
Animal drover / Droving aid	6	MOVIT-M
Animal drover (electronical)	6	KAWE 8001
Animal drover (electronical)	7	KAWE 21
Band saw blades / circular knife blades (optional accessories)	103	OPTIONAL
Bearing plastic design	86	TRIMMER
Breaking saw blades / reciprocating saw blades / band saw blades (optional accessories)	102	OPTIONAL
Breastbone shear	37	BBS14
Captive bolt stunner for concussion stunning	26	SCHERMER KC
Captive bolt stunner in extended design	25	SCHERMER KL
Captive bolt stunner in shortened design	25	SCHERMER KK
Captive bolt stunner of series K	24	SCHERMER K SERIES
Captive bolt stunner (pneumatic)	22	STUN-BP1
Captive bolt stunner with automatic bolt retraction system	25	SCHERMER KS
Captive bolt stunner with bolt discharge	24	SCHERMER KR
Circular bacon saw	69	BCK23-03
Circular breaking saw	66	K16-P4_evo2
Circular breaking saw	66	K18-01
Circular breaking saw	66	K18-13
Circular breaking saw	67	K23-03
Circular breaking saw	67	K23-06
Circular breaking saw	68	K28-06
Circular breaking saw	68	K32-06
Circular brisket knife	38	BBKM25-06D
Circular cutting knife	62	ZKM75-DA
Circular cutting knife	62	ZKM75-DA-JHS
Circular cutting knife	63	ZKM95-DA
Circular cutting knife as a modular table version	61	ZKM75-T
Circular cutting knife - Tabletop version	59	ZKM25-13PC
Circular foot saw	65	FK40-08
Circular horn and leg saw	36	HBK28-06
Circular horn and leg saw	36	HBK33-08
Circular saw blades (optional accessories)	101	OPTIONAL
Circular splitting saw	39	SK32-06L
Circular splitting saw	39	SK52-08L
Compressed air compressor	22	COMP-BP1-1
Compressed air compressor	23	COMP-BP1-2
Connection unit EF2	83	TM-E6001 EF2_evo2
Cranial insertion rod	30	RÜCKENMARKZERSTÖRER
Cutting table with automatic discharge conveyor (foldable)	64	ZKM-T-2CB
Dehider	37	SD11
Disinfection cabinets / disinfection pools (optional accessories)	106	OPTIONAL
Electric motor	75	TM-E6000_evo3
Electric motor	83	TM-E6001_evo2
Electric stun tong	8	STUN-TONG-EP STEEL
Electric stun tong	8	STUN-TONG-EA STEEL
Electric stun tong	8	STUN-TONG-ES STEEL
Electric stun tong	10	ZK-1
Electric stun tong	10	ZK-3
Electric stun tong	11	ZK-4
Electric stun tong	11	Z-KT
Electric stun tong (pneumatic)	9	STUN-TONG-EPP2
Electric stun tong (pneumatic)	9	STUN-TONG-EPP3
Electric stun tong (pneumatic)	14	STUN-TONG-EPP3 F-Serie

Electric stun tong (pneumatic).....	16	STUN-TONG-EPP3 E-Serie
Electric stun tong (standard).....	10	ZK-2
Electronic stimulation device (electronical).....	30	STIM-E512
Exploded view of one of the possible variants for TRIMMER E90_evo3.....	78	TRIMMER_evo3
Extension rod for KAWE 21 / KAWE 8001	7	EXTENSION ROD
Foot and neck shear.....	32	FNS9
Hand piece for VSS vacuum suction system (optional).....	47	VSS-VH38B
Hand piece for VSS vacuum suction system (optional).....	47	VSS-VH38G
Hand piece for VSS vacuum suction system (optional).....	47	VSS-VH38H
Hand piece for VSS vacuum suction system (optional).....	47	VSS-VH38E-2106
Hand piece for VSS vacuum suction system (optional).....	47	VSS-VH38I
Hand-Skinner (pneumatic).....	98	HSK-8P3_evo2
Hand-Skinner (pneumatic).....	98	HSK8-P5
Head dropper and general cutting shear	34	HDS15
Heart electrode, automatically movable	15	STUN-HE-PP
Heart electrode, automatically movable	17	STUN-HE-PP
High-performance cartridges Cal .27" 6,8/15 mm.....	27	OPTIONAL
Horn and leg shear.....	34	HLS12
Horn cutter.....	35	HZ7
Horn cutter.....	35	HZ10
Horn guillotine	35	HG12
Inspection package for electric stunners of the FREUND brand	21	STUN-E-INSPECTION
Interface control boxes (suitable for STUN-E8XXL).....	17	STUN-IF1-E8 / STUN-IF2-E8
Interface control boxes (suitable for STUN-F8).....	15	STUN-IF1-F8 / STUN-IF2-F8
Leg shear.....	34	LS15
Middle splitter circular knife blade.....	63	ZKM60-DA-MS
Modular construction Trimmer_evo3	76	TRIMMER_evo3 FEATURES
Neck shear	33	NS21
Neck shear	33	NS26
Neck shear	33	NS26-H1
New quality Trimmer_evo3.....	74	TRIMMER_evo3
Pneumatic-motor.....	82	PNM2
Quality trimmer	82	TRIMMER
Quartering and circular breaking saw.....	58	K28-06L
Quartering and circular breaking saw.....	58	K32-06L
Quartering breaking saw	56	ST40-13
Quartering breaking saw	57	ST30-11S
Quartering breaking saw	57	ST40-11S
Quartering shear	56	AS28
Reciprocating breastbone saw.....	40	BBST30-13
Reciprocating breastbone saw.....	40	BBH30-03
Reciprocating splitter saw	41	SST50-13
Reciprocating splitting saw	41	SH60-03
Rectum cutter	46	EDF
Rib top circular saw	69	RTK18-13
Rib Top Cutter	71	RTC34
Ring blade application.....	81	TRIMMER_evo3
Ring blade application.....	89	TRIMMER
Ring blade selection.....	80	TRIMMER_evo3
Ring blade selection.....	88	TRIMMER
Ring blade selection & application.....	51	TRIMMER (VACUUM SUCTION)
Sharpening steel	97	SCHÄRFSTAHL
Sharpening steel for work tables.....	97	SCHÄRFSTAHL für Arbeitstische
Sharpening steel hook	97	SCHÄRFSTAHL-HAKEN
Spare ribs cutter.....	70	SRC34-H5_evo2

ANIMAL SPECIES

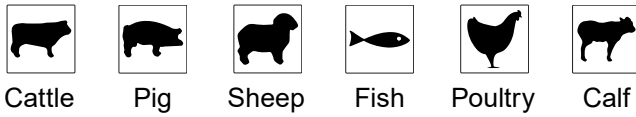

Cattle Pig Sheep Fish Poultry Calf

ANIMALS PER WEEK

Trade	Medium plants	Industry
1 - 20	21 - 500	> 500
1 - 100	101 - 5 000	> 5 000
1 - 200	201 - 10 000	> 10 000

CARCASS (DEAD) WEIGHT

	< 200 kg	200 - 400 kg	> 400 kg
	< 80 kg	80 - 120 kg	> 120 kg
	< 15 kg	15 - 25 kg	> 25 kg

TECHNICAL DATA

Weight (of the tool)	Protection class
Saw blade diameter	Drive type
Saw blade / Cutting length	Pressure
Cutting depth	Power
Shear opening	Cable extension
Stroke	Tensile strength of cable
Diameter	Saw blade teeth

Saw blade thickness

CUTTING SYMBOLS PAGE

	Droving	6-7
	Stunning	8-27
	Stimulation	30
	Bleeding	31
	Weasand clip	31
	Feet/neck	32
	Neck	33
	Horns/legs	34-36
	Horns	35
	Breastbone	37-38, 40
	Dehiding	37
	Rectum	46
	Splitting	39-43
	Vacuum action	44-51
	Quartering	56-58
	Primal cutting	59-71
	Trimming	73-98

WE ARE DIGITAL

FREUND ASSISTANCE



Mok-Up Designed by zlatko_plamenov / Freepik

A couple of clicks, no waiting times, using a PC, smartphone or tablet at any time of day or night: our customer portal provides you with information and functions relating to our machines - at any time of day!

We're going digital for you to unite you as a customer with us on one platform – communication and data exchange as you have never experienced it before with FREUND.

Operating manual and login can be found on our website :

<https://www.freund.eu/freund-assistance.html>

ADVANTAGES FOR OUR CUSTOMERS

- Find your FREUND machines and FREUND devices
- You can navigate your way around the respective machine
- Find, view and print a spare parts list
- Operating manuals for our machines/devices
- Installation manuals for our machines/devices
- SRC technical information
- Send order requests directly to FREUND Sales by email, done directly from the customer portal
- Further users (multi-user login) can be created per customer on request

The advantages to the customer are at the forefront of everything we do. Our customer portal is of course available to you free of charge. After all, customer relations is a top priority for FREUND. Please give us a call on

+49 5251 1659-0 .

FREUND Maschinenfabrik GmbH & Co. KG

Schulze-Delitzsch-Str. 38
33100 Paderborn, GERMANY
mail@freund.eu

Fon: +49 5251 1659 -0
Fax: +49 5251 1659 -75
www.freund-germany.com

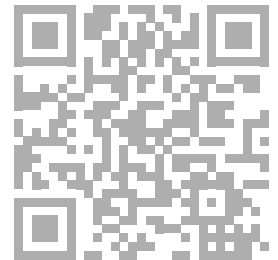

DE



ES



FR



RU

